



*An Online PDH Course
brought to you by
CEDengineering.com*

Home Energy Savings: A Practical Approach

Course No: M09-001
Credit: 9 PDH

Elie Tawil, P.E., LEED AP



Continuing Education and Development, Inc.

P: (877) 322-5800
info@cedengineering.com

www.cedengineering.com

Home Tightening, Insulation and Ventilation



- 🏠 Lower your utility bills with energy-efficient home improvements
- 🏠 Plug air leaks, inside and out—page 3
- 🏠 Insulation can pay for itself in just a few years—page 14
- 🏠 Ventilation is one of the keys to year-round energy savings—page 22

A little effort can pay big dividends

The average Iowa family spends more than half of its annual household energy bill on heating and cooling. That's a significant number, but you can dramatically reduce these costs—up to 20 percent, according to ENERGY STAR®—by making some simple energy-saving **weatherization** and **insulation** improvements to your home. In addition—with a little attention to proper **ventilation**—you can protect your home from moisture damage year-round, reduce problems caused by ice dams on the roof during the winter and significantly cut summer cooling costs. As a bonus, these projects can extend the life of your home and may increase the resale value of your property.

? Did you know?

Many utilities will perform a free energy audit on your home and identify areas needing insulation and other improvements.

If you like to fix things around the house, you can handle many of the projects suggested in this book and make the most of your energy-improvement budget. However, don't hesitate to call a professional for help if you'd rather not do the work yourself; the dollars gained through energy savings in upcoming years will be worth the expense.

Check with your utility or bank first

Although many energy-efficiency projects—caulking windows, weather-stripping exterior doors or insulating water pipes—will cost just a few dollars, others—insulating exterior walls, installing ventilated soffits or adding storm windows—will cost considerably more. Some utilities offer **rebates** on larger projects by giving you a discount on future heating and cooling bills or even sending you a rebate check when the work is completed.

Your bank may be able to help too. Ask about a **low-interest loan** designed to cover the cost of your energy-saving projects, or consider a home-improvement loan to fund them.

Be sure to look into the availability of government-sponsored **assistance and grant programs** designed for low-income and elderly homeowners too. For more information, get in touch with the Iowa Department of Human Rights/Division of Community Action Agencies or a Community Action Agency in your area. (See page 24 for a list of contacts.)

Finally, check on national and state incentives for the installation of energy-efficient products. For details on federal income tax credits, visit the Web site of the Tax Incentives Assistance project at <http://www.energytaxincentives.org>. For state programs, go to the Database of State Incentives for Renewables & Efficiency (DSIRE) at <http://www.dsireusa.org>.

Get the most for your money

To help you decide which jobs to tackle first, consider more than just the increased comfort you'll experience; analyze their **return on investment** too. It usually makes sense to start with the ones that cost the least now but offer the most later in terms of energy dollars saved.

It's easy to figure how long it will take for your energy improvements to pay for themselves through reduced energy bills. Divide the total cost of each project by the annual estimated energy bill savings—ask your utility for help—to find the **payback period**. For example, if a project costs \$1,600 and you'll save \$200 per year, the payback period is eight years.

Eliminate air leaks—then insulate

You may think that insulating should be the first step in making your home more energy-efficient, but consider this: Air leaks through the ceiling, walls, foundation and other areas typically are the greatest sources of heating and cooling losses in a home. So, controlling air leaks is the best way to extend the life of your home, as well as to conserve energy, save money and increase your home's comfort. The bottom line is this: *If you don't tighten up your home first, money spent on insulation may be wasted.*

Sources of air leaks in a typical home

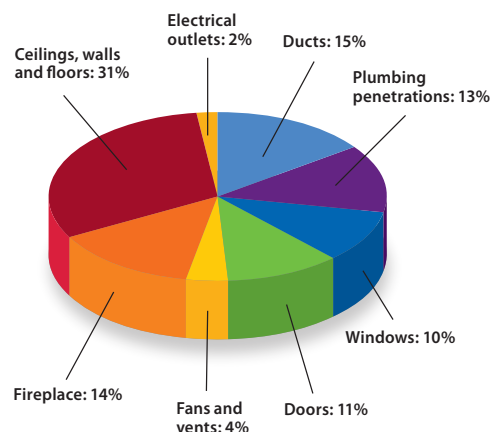

Air infiltrates into your home through every hole, nook and cranny. About one-third of this air infiltrates through the openings in your ceilings, walls and floors.

According to the U.S. Department of Energy, you can save 10 percent or more on your energy bills just by plugging air leaks in these places in your home.

Source: U.S. Department of Energy Office of Energy Efficiency and Renewable Energy

Home Tightening

Ventilation is a good thing—air infiltration is not

Every home needs a certain amount of fresh air for the furnace and appliances that burn fuel, for getting rid of excess moisture and reducing odors and stuffiness. When this air exchange is controlled, it's called **ventilation**.

A large amount of air is exchanged in uncontrolled and invisible ways, too, through hidden cracks and openings present in every home. This is called **infiltration**.

- ▶ *Wind-driven infiltration* happens during cold-weather months when the wind blows cold air into a house and forces hot air out. During warmer weather, the wind blows in warm air, forcing cooler air out.
- ▶ *Chimney effect infiltration* takes place during the natural process of convection. As warm air rises and escapes through cracks, it pulls cold air into the lower portion of a house.
- ▶ *Negative air pressure infiltration* starts when appliances that burn fuel use air for combustion or when ventilation fans exhaust air. Outdoor air enters through any available openings to equalize the pressure inside a home.

Typically, air infiltration causes drafts and a chilly feeling in some rooms during the cool-weather months. Adjusting your thermostat will not stop the drafts, but sealing hidden cracks and openings will. By stopping drafts at their source, you'll stay warmer at lower thermostat settings, use less fuel and reduce your utility bills. During the summer, plugging air leaks will cause your air conditioner to cycle less often.

Start by searching for air leaks

Fortunately, air infiltration is one of the easiest forms of heat loss to correct. The process requires only a careful inspection of your home and some inexpensive weather stripping, caulking and filler materials.

Most people know they should caulk and weather-strip various spots around the exterior of their homes to protect them from the elements. However, it is equally important to protect your home from interior air leaks. Moist interior air can enter the walls and ceiling through cracks and holes, and condensation buildup in those locations can damage or destroy insulation, wiring, wood and other building materials.

Test for leaks

The first step is performing a **detailed inspection** of your home for air leaks. You can do this yourself during a windy day or hire a professional energy auditor to identify where heat loss is occurring in your home and how to stop it.

A professional energy audit may include **thermography**—infrared scanning with a still or video camera to locate air leaks and missing insulation—but it definitely should include a **blower door test**. A blower door is a large fan that fits tightly into an exterior doorway in your home. It depressurizes the space inside your home, which then causes air to flow in through the cracks and other openings. The energy auditor then can walk around and tell you where the leaks are by feeling for airflow by hand or by using a *smoke pencil* and noting where the smoke is blown.

You can perform a similar test yourself by closing all the windows and doors and using a whole-house fan or a large portable fan temporarily sealed in an open window to exhaust the air from your home. Use your hand or a lighted incense stick to look for leaks. This home version of the test won't be as accurate as the professional test, but it can get you started.

Once you've located the air leaks in your home, you're ready to start plugging them. A good rule of thumb is to **seal the high and low air leaks first**; in other words, start by plugging holes and leaks in the attic and basement. Then move to the exterior walls, and look for smaller leaks around doors, windows and electrical switches and outlets.

Did you know?

If you're building a new home or putting an addition on your existing one, consider enveloping the new structure with a house wrap as a secondary weather barrier (behind the siding). Think of the house wrap as a raincoat under the siding; not only will it help reduce air and water infiltration into your home, but also it will "breathe" to allow moisture to escape from your home's walls.

How does air escape?

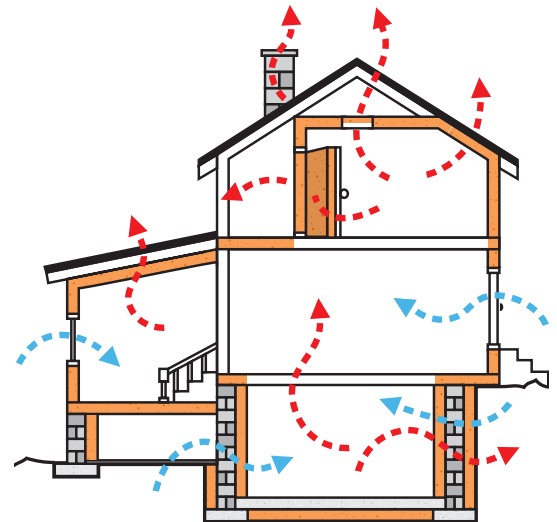

Plugging air leaks after a careful inspection of your home's structure—both inside and outside—can yield a significant reduction on your monthly heating and cooling bill. In this illustration, blue arrows indicate outside air infiltration and red arrows show where conditioned (heated or cooled) air can escape.

Insulate the attic hatch

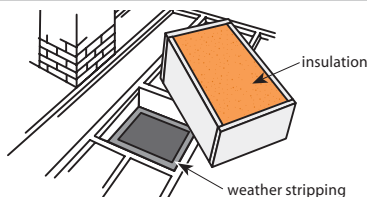

If you have an attic hatch, make sure it fits tightly and is backed by insulation. Do this by weather-stripping the edges of the access hole and building a simple wood box to hold insulation on the backside of the hatch. As an alternative, purchase an insulated hatch cover.

? Did you know?

To learn more about performing an energy audit and identifying the best methods and materials for saving energy at home, visit these Web sites.

- ▶ **Lawrence Berkeley National Laboratory Home Energy Saver:**
<http://hes.lbl.gov>
- ▶ **ENERGY STAR® Home Energy Yardstick:**
<http://www.energystar.gov>
- ▶ **U.S. Department of Energy Do-It-Yourself Home Energy Audits:**
<http://www.eere.energy.gov>
- ▶ **Alliance to Save Energy Home Energy Checkup and Audit:**
<http://www.ase.org>

Fix attic air leaks

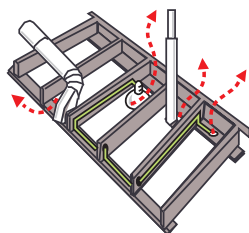

Recessed lights, wiring, plumbing and other openings in insulated ceilings and walls can result in a tremendous amount of heat loss.

Look for air leaks in your home

Exterior

Holes for utility pipes and wires	Caulk or foam around openings for electric, gas, oil and water-supply lines; drainage pipes; plumbing for outside spigots; cable or satellite TV and telephone cables.
Vents	Caulk or foam around dryer vents, heating and cooling system vents and fresh-air supply vents for fuel-burning furnaces and water heaters.
Windows	Caulk around window frames. If you have combination storm windows, caulk around the windows where the metal storm window frame meets the window's frame; don't seal the moisture weep holes at the bottom of the frame. If you have wooden storm windows that must be exchanged for screens in the spring, use non-permanent, non-staining rope caulk to seal around them.
Doors	Caulk around door frames. Install storm doors where you have none.

Attic

Hatches and doors to the attic	Weather-strip the edges of the access hole and insulate the back of each attic hatch and door.
Holes in attic floor	Seal all holes for wires, pipes, ducts and vents with a good general-purpose caulk or spray foam. You may need to use a filler material for larger holes.
Chase for plumbing stack(s)	This channel may run inside the walls of your home, from the basement to the attic, with openings at each floor where the pipes branch off. If the chase isn't much larger than the pipes, seal with expanding foam. For larger chases, use drywall, wood or rigid foam—and caulk or foam around all edges.
Fireplace chimney and vent flues for furnace and water heater	Close the gap between house framing and the chimney and vent flues with 26-gauge sheet metal; seal the edges with high-temperature caulk.
Interior walls and partitions	Caulk or foam along the tops of interior walls where the top plate meets the plaster or drywall.
Exterior walls	Caulk along the tops of exterior walls where the top plate meets the plaster or drywall.
Soffits (usually in kitchen or bath) or a change in ceiling height	Caulk along the joints where the walls change height.
Attic knee wall storage drawers	If storage drawers are recessed into the attic space, build an airtight, insulated box around the backside of the drawers.
Other holes	Using the appropriate materials, seal all other holes between the heated space in your house and the attic.

Basement

Sill plate and band joist	Caulk any crack between the sill plate and foundation wall using a caulk that works well with masonry. Use caulk to fill any cracks between the sill plate and band joist. Then insulate the band joist area. (See page 19.)
Chase for plumbing stack(s)	This channel may run inside the walls of your home, from the basement to the attic, with openings at each floor where the pipes branch off. If the chase isn't much larger than the pipes, seal with expanding foam. For larger chases, use drywall, wood or rigid foam—and caulk or foam around all edges.
Vent flues for furnace and water heater	Close the gap between house framing and the chimney and vent flues with 26-gauge sheet metal; seal the edges with high-temperature caulk.
Openings running through basement ceiling	Seal the hole where the bathtub drain comes down and any other holes for plumbing or electrical wiring in the basement ceiling with caulk or foam. You may need to use a filler material for larger holes.
Ducts	In homes with forced-air heat, there may be large cracks or gaps where the ducts pass through the ceilings, floors and walls. Caulk or foam where the metal duct opening and the ceiling, floor or wall meet.
Basement windows	Using a caulk that works well with masonry, fill cracks where the frames of the windows are set into the walls. Windows that are not used for summer ventilation or as fire exits can be caulked shut permanently.
Hatch or door to the crawl space	Weather-strip the edges and insulate the back of the hatch or door.
Other holes	Seal any cracks or holes in the foundation of your house with caulk, foam or the appropriate patching material.

Living spaces

Door frames, trim and baseboards	Caulk around frames for exterior doors and around trim and baseboards with an interior-grade caulk. Use a clear-drying caulk for hardwood or tile floors and trim with natural wood finishes—and paintable caulk for painted trim and carpeted floors.
Windows	Check the weather stripping on all windows, and repair or replace as necessary. Replace broken glass and reglaze or putty any loose window-panes. Caulk all cracks between the walls and window frames and trim, especially under the windowsills. During the cold-weather months, caulk around the moving parts of windows with a strip-away, non-permanent caulk you can remove easily in the spring.
Electrical switches and outlets	Install foam gaskets on all switches and outlets—even on interior walls. Use child-safety plugs to minimize the amount of cold air coming through the sockets.

continued on page 6

Seal around the chimney

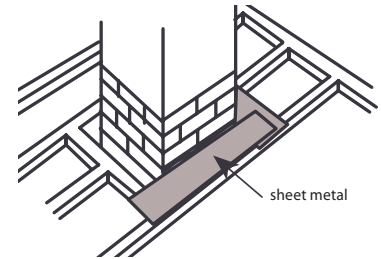

Heat can escape around the chimney if it isn't properly sealed with sheet metal and the appropriate caulk.

Caulk basement air leaks

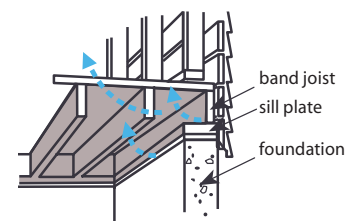

Get rid of drafts on the main floor by caulking along the sill plate and band joist in the basement.

Did you know?

Standard and premium caulks generally are formulated for application at temperatures above 40 degrees. If you must repair an air leak during cold-weather months, be sure to buy a caulk specifically designed for that purpose.

Add foam gaskets

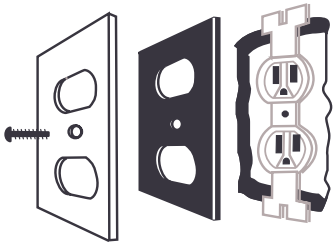

Install foam gaskets between electrical outlets or switches and their coverplates. Plastic plugs—such as “child safety” inserts—also will prevent air from entering your home.

CAUTION!

Before starting to seal air leaks around wires, switches, outlets, exhaust fans, recessed lights or electrical boxes, turn off the power to those devices at the circuit breaker box or fuse box.

continued from page 5

Recessed lights and bathroom fans	These fixtures can poke into the attic insulation and create a pathway for air leaks. Caulk around them from below with flexible, high-temperature caulk.
Missing plaster	Exposed laths indicate a direct hole into wall and ceiling cavities. Repair with plaster or cover with new drywall.
Cracks in plaster and drywall	Repair cracks using the appropriate patching material, and repaint.
Other holes in ceilings or exterior walls	Caulk or foam around all ceiling fixtures, heat registers, medicine cabinets, bathtubs, kitchen cabinets, drains and water pipes where they enter the wall in the kitchen and bath. Also seal any other holes in exterior walls.
Fireplace damper	A missing or poorly fitting damper allows air to move freely up and down the chimney. Install a new damper or repair the existing one, so it closes tightly.

A fireplace can waste more heat than it creates

A charming old fireplace may seem warm and cheery, but when there’s no fire burning the fireplace can cause substantial heat loss from your home. Even if you close the fireplace damper and it leaks just a little, a lot of warm air from your home will be sucked up the chimney and be replaced by cold air leaking into the house.

If you never use the fireplace, put a plug in the flue of the chimney to reduce heat loss. Seal the plug to the chimney with caulk, and be sure to tell anyone who may want to start a fire that the chimney is plugged. You also can secure the damper in place and caulk around it to eliminate air leaks.

If you use the fireplace, follow these tips:

- ▶ Every year, have the fireplace and chimney inspected and cleaned by a certified chimney sweep. Creosote buildup in the chimney can ignite, causing a fire that easily can spread to the walls or roof.
- ▶ Check the seal of the flue damper. Close the flue, light a small piece of paper (or an incense stick) and watch the smoke. If the smoke goes up the flue, there’s an air leak. Seal around the damper assembly with refractory cement, but don’t seal the damper closed. If the damper has warped from high heat, have a sheet metal shop fabricate a new one or install a metal chimney top damper.
- ▶ Inflate a chimney balloon in the chimney above the damper when you’re not using the fireplace. It inflates like an air mattress, expanding to seal air leaks; if you forget to remove it before starting a fire, it will react to the heat and quickly deflate.
- ▶ Install tight-fitting glass doors. Controlling the airflow in your fireplace improves combustion efficiency by 10 to 20 percent and reduces air leaks up the chimney.
- ▶ Add a heat-circulating grate with a built-in fan to blow heated air into the room; some models have a thermostat to reduce fan speed as the fire burns down. Be sure to buy a unit designed specifically for your style of fireplace.
- ▶ Make a tight-fitting plug for the fireplace opening from rigid board insulation backed by plywood with pipe insulation around the edge. Finish it to match the room’s decor, and insert it whenever the fireplace is not in use.

Caulking is easy and cost-effective

Use caulk to **permanently seal air leaks** in the cracks and gaps between window frames and your home's siding. Generally speaking, you can seal openings up to 1/4 inch. For larger gaps, add a backing material before caulking or use a spray foam sealant instead.

Most types of caulk are sold in tubes that fit a caulking gun. In addition, some caulks come in aerosol cans; they're a good choice for filling gaps up to 1/2 inch.

When shopping for caulk, you will find prices ranging from under a dollar to several dollars per tube, so be sure to read the labels on the tubes and choose the caulk that will adhere best to the materials you're sealing. If your budget allows, spend a little more for a higher-quality caulk. Inexpensive caulks may last only a few years, while premium-priced caulks are rated for 20 years or more.

Also note that some caulks are for indoor use only. In addition, some caulks combine different chemistries; for example, you'll see *acrylic-latex* or *acrylic-latex with silicone* caulks.

Once you have applied the caulk, it takes time for it to dry, or *cure*. Curing time is described two ways. The *tack-free time* tells you how quickly the fresh caulk's outer surface will dry—or skin over. The *total cure time* indicates the time required for the caulk to become completely stable—or reach the point where no further drying or shrinking will occur.

Most caulks pose no known health hazards after they're fully cured. However, some high-performance caulking compounds contain irritating or potentially toxic ingredients, and you should apply them only when there's adequate ventilation; carefully read the manufacturer's instructions and take the appropriate precautions. In addition, make sure pets and small children do not come into contact with fresh caulk.

Caulking materials

Silicone

Uses	Seals most dissimilar building materials such as wood, stone, metal flashing and brick
Shrinkage	Little or none
Adhesion	Good to excellent
Cleanup	Dry cloth immediately. Mineral spirits after curing starts, as specified on package.
Cost	High
Comments	Permits joints to stretch or compress. Sticks to painted surfaces, but most cured silicones not paintable. Very durable and long-lasting; some rated 20 years or more.

Latex

Uses	Seals joints around tub and shower. Fills cracks in tile, plaster, glass and plastic; fills nail holes.
Shrinkage	5% to 10%
Adhesion	Good to excellent
Cleanup	Water, as specified on package
Cost	Low to moderate
Comments	Easy to use. Smooth seams with moist finger or tool. Water-resistant when dry. Paintable. Less elastic than other materials. Varied durability of 2 to 10 years. Will not adhere to metal. Little flexibility once cured. Must be painted when used on exteriors.

continued on page 8

? Did you know?

If you're replacing windows in your home, caulk twice—first, where the window meets the sheathing and second, between the window trim and the siding. If you're building a new home or putting an addition on your existing one—and you're using a house wrap/weather barrier under the siding—be sure to follow the installation instructions that come with that material.

A dollar's worth of prevention



Check for air leaks in weather stripping around windows and exterior doors by closing them on a dollar bill or a strip of paper in several locations around their perimeters. If you easily can remove the bill (or it falls out), the weather stripping needs to be repaired or replaced. Also perform a visual check of every weather strip, looking for cracked, deformed or missing sections.

Caulk like a pro



Here are some tips to follow.

- ▶ As a rule of thumb, you'll probably use half a cartridge per window or door and up to six cartridges for foundation work.
- ▶ Before applying new caulk, remove old caulk or paint residue with a putty knife, stiff brush or special solvent.
- ▶ Make sure the area is dry, so you won't seal in moisture.
- ▶ Hold the caulking gun at a consistent angle; 45 degrees is best.
- ▶ Caulk in a straight, continuous stream, avoiding stops and starts.
- ▶ Make sure the caulk sticks to both sides of the crack or seam.
- ▶ Release the trigger on the caulking gun before pulling it away from the crack to prevent applying too much caulk. A caulking gun with an automatic release makes this much easier.
- ▶ If caulk oozes out of a crack, use a putty knife to push it back in.
- ▶ Don't skimp. If the caulk shrinks, reapply it to form a smooth bead that completely seals the crack.

? Did you know?

In their original tubes, some caulks have a shelf life of a year or less—especially if the tubes have been opened. Don't buy caulk until you're ready to use it, and tightly seal opened tubes between jobs.

continued from page 7

Butyl rubber

Uses	Seals most dissimilar materials such as glass, metal, plastic, wood and concrete. Seals around windows and flashing. Bonds loose shingles.
Shrinkage	5% to 30%
Adhesion	Good
Cleanup	Mineral spirits, as specified on package
Cost	Moderate to high
Comments	Durable; lasts 10 or more years. Resilient, not brittle. Paintable after one week curing. Variable shrinkage. May require two applications. Does not adhere well to painted surfaces. Toxic; follow label precautions.

Oil- or resin-based

Uses	Seals exterior seams and joints on building materials
Shrinkage	10% to 20%
Adhesion	Good
Cleanup	Mineral spirits, as specified on package
Cost	Low
Comments	Usually least expensive. Rope and tube forms available. Oils dry out and cause material to harden and fall out. Low durability of 1-4 years. Poor adhesion to porous surfaces such as masonry. Should be painted. Can be toxic—check label. Limited temperature range.

Urethane

Uses	Seals most dissimilar building materials such as vinyl, wood, stone, metal flashing and brick
Shrinkage	Little or none
Adhesion	Excellent
Cleanup	Solvent (such as xylene), as specified on package
Cost	High
Comments	Permits joints to stretch or compress. Sticks to painted surfaces and is paintable. Very durable. Takes a week or more to fully cure. Often available only at commercial construction or building supply outlets.

Source: U.S. Department of Energy Office of Energy Efficiency and Renewable Energy

Use expanding foam for large gaps

Expanding foam is ideal for filling cracks that caulks can't handle. It comes in aerosol cans and takes a short time to cure. The foam is very sticky and attaches itself quickly, so be prepared to pick up any messes fast.

You also can use foam instead of caulk for applications such as sealing along the tops of interior walls where the top plate meets the plaster or drywall in your attic; low-expansion foam will stick better to dusty and dirty surfaces in your attic than caulk.

In fact, when you're working in a large area such as your attic, it may be inconvenient to carry and keep track of several cans of expanding foam. Instead, consider renting a contractor's foam gun, which has a long nozzle and can help you get into tough-to-reach spaces.

Expanding foam

Water-based, low-expansion foam sealant

Uses	Around window frames and door frames, in small cracks
Shrinkage	None; expands only 25%
Adhesion	Good to excellent
Cleanup	Water
Cost	High
Comments	Best for most applications. Takes 24 hours to cure to soft consistency. Water-based foam does not produce greenhouse gases. Will not overexpand to bend window or door frames. Must be exposed to air to dry. Not useful for larger gaps, as curing becomes difficult.

Polyurethane expanding spray foam sealant

Uses	Expands when curing; good for larger cracks indoors or outdoors. Use in non-friction areas, as material becomes dry and powdery over time.
Shrinkage	None; expands quite a bit
Adhesion	Good to excellent
Cleanup	Solvent such as lacquer thinner, immediately
Cost	Moderate to high
Comments	Quickly expands to fit larger, irregularly shaped gaps; may put excessive pressure on sides of gaps. Flexible. Can be applied at variable temperatures. Must be painted for exterior use to protect from ultraviolet radiation. Manufacturing process produces greenhouse gases.

Source: U.S. Department of Energy Office of Energy Efficiency and Renewable Energy

Try these materials for special jobs

In addition to the types of caulk and spray foam sealant described above, you may need to use **fillers** to plug extra-wide gaps. Fillers come in a wide variety of materials—cotton, fiberglass, foam and sponge rubber—and you can find them in the caulking department of your local hardware store or home center. However, these fillers are not designed for exposure to the elements; you'll need to caulk or seal over them.

To close gaps too wide for foam, use foil-faced bubble wrap. And for really large holes, cut sections of rigid foam insulation to fit and glue into place with expanding foam—before covering the area with wood or another appropriate building material.

For winter, use **rope caulk** to seal windows and other spots that you'll want to be able to open during the spring. Rope caulk is a gray, putty-like material that comes in long strips or rolls. It's easy to install and remains flexible—and you can pull it off when the weather turns warm. Note that rope caulk will not last longer than a year, and oil-based rope caulk may stain painted areas.

Seal around pipes in exterior walls



Expanding foam sealant works well for sealing gaps more than 1/4-inch wide.

CAUTION!

When you go shopping for expanding foam to fill gaps around window and door frames, look for the type made specifically for that task. Standard expanding foam may expand so much that it will put pressure on the frames and bend them.

Did you know?

A 1/8-inch air gap under an exterior door may seem insignificant, but it will let as much cold air into your home as a four-inch-diameter hole punched in the wall!

Weather-stripping doors and windows is the next step

After you've handled the larger air leaks in your home's attic, walls and basement, tackle the smaller leaks by weather-stripping doors and windows. If you do the doors and windows first, you'll just be adding to the *chimney effect* in your home that allows warm air to rise and escape through the attic, pulling outside air into the main level.

Weather stripping prevents air infiltration around doors and windows by sealing the gaps between the frames and moving parts when they're closed. With weather stripping, one or both surfaces of a door or window must be free to move, as opposed to caulking, which builds a permanent seal between two stationary surfaces.

Weather stripping comes in several sizes and shapes (often designed for specific uses) and may be made from metal, plastic, vinyl, rubber, felt or foam—or a combination of these materials. You should weather-strip all exterior doors, along with any doors that lead to unheated areas, such as the attic, garage or basement. In addition, weather-strip all operable windows.

You can buy weather stripping by the foot or in kits at a local hardware store or home center. Before you buy anything, determine what kind of weather stripping you want to use. Checking the size of the gap between the fixed and moveable sections of your doors and windows, as well as thinking about the amount of expected wear and tear in these areas, will help you decide which material is the most appropriate. Obviously, less-durable materials will have to be replaced more frequently.

You can calculate the amount of weather stripping you'll need by measuring the perimeter of all the doors and windows to be weather-stripped. It's a good idea to add five to ten percent more for waste.

Keep in mind that less-durable materials such as felt or foam will have to be replaced more frequently. Weather-strip doors and windows all the way around their outer edges. It's best to apply one continuous strip along each edge (or joint), making sure the weather stripping is tight at the corners.

For self-adhesive products, be sure to clean the surfaces to which you'll be applying the weather stripping. In addition, follow the manufacturer's directions for the minimum outdoor temperature needed for a solid installation; some weather-stripping adhesives lose their initial gripping power in temperatures under 40-50 degrees F.

Weather-stripping materials

Tension seal

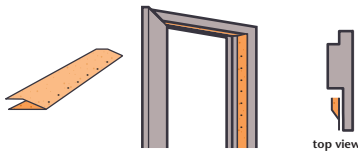

Description	Self-stick plastic or vinyl, folded along its length in a V-shape; also a springy bronze (copper, aluminum or stainless steel) strip shaped to bridge a gap and nailed in place. Material creates a seal by pressing against the sides of a crack to block drafts.
Uses	Inside the track of a double-hung or sliding window and top and sides of door
Cost	Moderate. Varies with material used.
Advantages	Durable. Invisible in place. Very effective. Vinyl is easy to install. Look of bronze works well for older homes.
Disadvantages	Surfaces must be flat and smooth for vinyl. Can be difficult to install, as corners must be snug. Bronze must be nailed in place to prevent bending or wrinkling. Can increase resistance in opening and closing doors or windows. Some kit manufacturers include an extra strip for the door striker plate.

Felt

Description	Plain or reinforced with a flexible metal strip; sold in rolls. Must be stapled, glued or tacked into place. Seals best if staples are parallel to the length of the strip.
Uses	Around a door or window, fitted into a door jamb so door presses against it
Cost	Low
Advantages	Easy to install. Inexpensive.
Disadvantages	Low durability. Least effective at preventing airflow. Do not use where exposed to moisture or where there is friction or abrasion. All-wool felt more expensive, but more durable. Very visible.

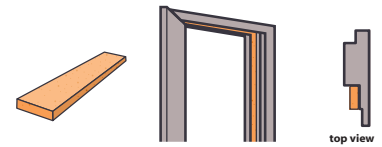

Foam tape

Description	Nonporous, closed-cell foam, open-cell foam or EPDM (Ethylene Propylene Diene Monomer) rubber
Uses	Top and bottom of window sash, door frames, attic hatches and non-operable windows. Good for blocking corners and irregular cracks.
Cost	Low
Advantages	Extremely easy to install. Works well when compressed. Inexpensive. Self-adhesive may not adhere well in cold weather. Can be reinforced with staples.
Disadvantages	Durability varies with material used, but not especially high for most types. Use where little wear is expected. Visible.

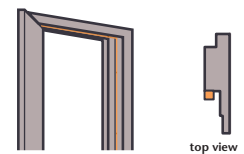

Reinforced vinyl

Description	Pliable or rigid strip gasket attached to wood, plastic or metal strips
Uses	Door or window stops, top or bottom of window sash
Cost	Low to moderate
Advantages	Easy installation. Low to moderate cost. Some types of rigid strip gaskets provide slot holes to adjust height, increasing durability.
Disadvantages	Visible. Self-adhesive on pliable vinyl may not adhere well to metal or during cold weather.

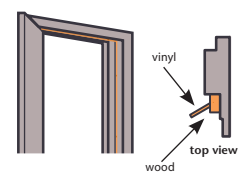

Door sweep

Description	Aluminum or stainless steel with a brush of plastic, vinyl, sponge or felt
Uses	Bottom of interior side of in-swinging door, bottom of exterior side of out-swinging door
Cost	Moderate to high
Advantages	Relatively easy to install. Many types adjustable for uneven threshold. Automatically retracting sweeps also available to reduce drag on carpet and increase durability.
Disadvantages	Visible. Can drag on carpet. Automatic sweeps are more expensive and may require a small pause before retracting, once door is unlatched.

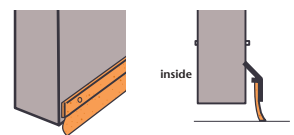

continued on page 12

continued from page 11

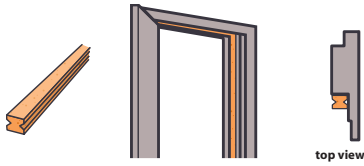

Magnetic

Description	Works similarly to refrigerator door gasket
Uses	Top and sides of doors, double-hung and sliding window channels
Cost	High
Advantages	Very effective air sealer
Disadvantages	Expensive

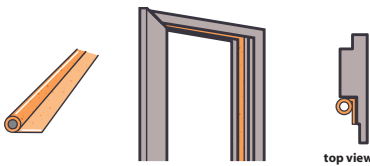

Tubular rubber

Description	Vinyl or sponge rubber tubes with a flange along length to staple or tack into place. Door or window presses against them to form a seal.
Uses	Around a door or window
Cost	Moderate to high
Advantages	Effective air barrier
Disadvantages	Self-stick versions challenging to install

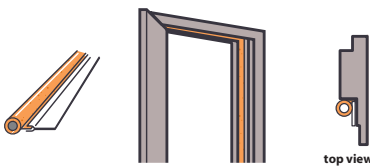

Reinforced silicone

Description	Tubular gasket attached to a metal strip that resembles tubular vinyl
Uses	On a doorjamb or a window stop
Cost	Moderate to high
Advantages	Seals well
Disadvantages	Installation can be tricky. Hacksaw required to cut metal; accurately butting corners poses a challenge.

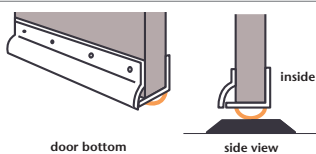

Door shoe

Description	Vinyl or sponge rubber tubes with a flange along length to nail or screw into place. Door presses against it to form a seal.
Uses	Seal space beneath door
Cost	Moderate to high
Advantages	On the exterior, product sheds rain. Durable. Can use with uneven opening.
Disadvantages	Fairly expensive. Installation moderately difficult. Door bottom planing may be required.

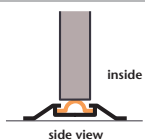

Bulb threshold

Description	Vinyl and aluminum
Uses	Door thresholds
Cost	Moderate to high
Advantages	Combination threshold and weather strip. Available in different heights and lengths.
Disadvantages	Wear from foot traffic. Relatively expensive.

Finned door bottom

Description	U-shaped vinyl with fins on bottom that contact threshold
Uses	Door bottom
Cost	Moderate
Advantages	An effective air-blocker when new; multiple fins seal even if one is damaged or worn. Easy to install.
Disadvantages	Very visible. Cutting to exact length is critical, or air can leak around ends. Entire unit must be replaced when fins are worn.

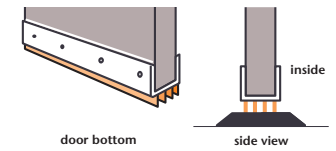

Frost-break threshold

Description	Aluminum or other metal on exterior, wood on interior; door-bottom seal and vinyl threshold replacement.
Uses	Seal beneath a door
Cost	Moderate to high
Advantages	Use of different materials means less cold transfer. Effective. Threshold is adjustable.
Disadvantages	Moderately difficult to install; involves threshold replacement.

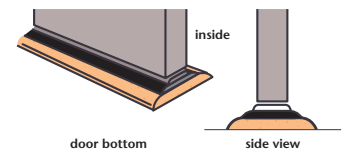

Fin seal

Description	Pile weather strip with plastic Mylar fin centered in pile
Uses	Aluminum sliding windows and sliding glass doors
Cost	Moderate to high
Advantages	Very durable
Disadvantages	Can be difficult to install

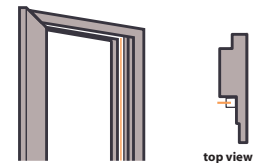

Interlocking metal channels

Description	Enables door and frame to engage one another when closed
Uses	Around door perimeters; also at bottom.
Cost	High
Advantages	Exceptional weather seal
Disadvantages	Very difficult to install; alignment is critical. Professional installation only.

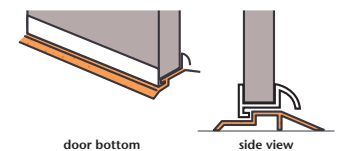

Source: U.S. Department of Energy Office of Energy Efficiency and Renewable Energy

Insulation

Did you know?

You can install your own insulation

For many insulating jobs, such as those in your attic and basement, handling the work yourself can save money. However, some jobs—insulating walls and foundations, for example—are more difficult and time-consuming. In those cases, calling a professional insulation contractor for installation may be the wisest choice.

Create an energy-saving thermal envelope for your home

Insulation slows down the heat flow through a building's envelope. A home's building envelope contains the walls, attic, roof and basement—basically everything that surrounds the space you want to keep warm in the winter and cool in the summer.

Insulation works all year long to make your home more comfortable and energy efficient. In the winter, it slows heat loss and helps prevent condensation buildup. During summer months, insulation reduces heat gain and helps keep your home cool.

Where to insulate

Source: U.S. Department of Energy Office of Energy Efficiency and Renewable Energy

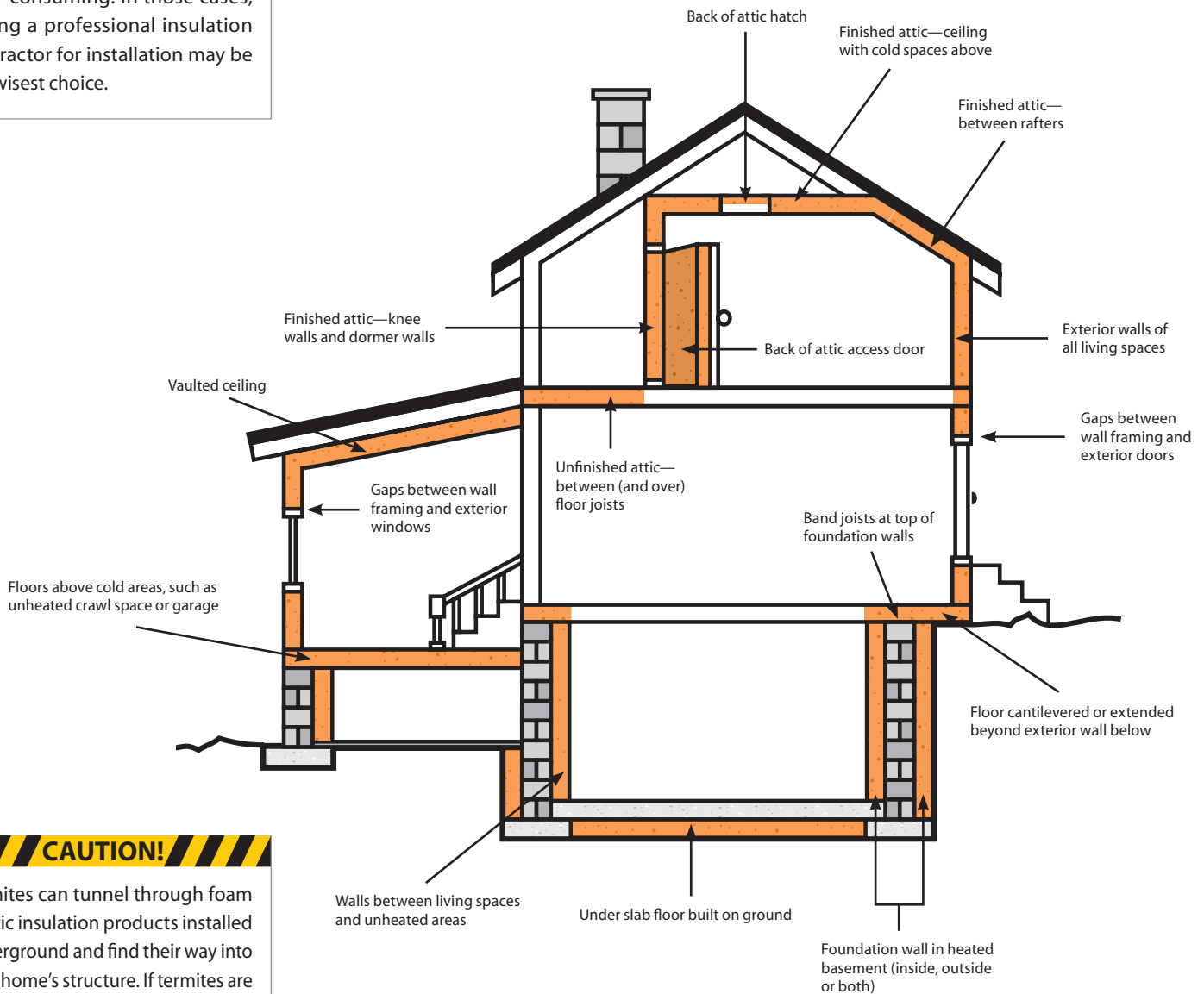

CAUTION!

Termites can tunnel through foam plastic insulation products installed underground and find their way into your home's structure. If termites are a problem in your area, talk with an insulation professional about using termite-resistant products and preventing termite infestations by other means.

Adding insulation to your home can cut heating and cooling costs anywhere from 15 to 45 percent, depending on factors such as the original amount of insulation in your home, house size, air leaks and personal energy use and living habits. Many variables affect the amount you'll save, but the fact remains that **insulating your home is a wise energy investment.**

The idea behind insulation is pretty simple

While every house is different, the basic rule of insulating is the same for all homes: **Install insulation on any surface separating a heated space from an unheated space.** Recommendations vary for the amount of insulation necessary for peak energy savings, depending on factors such as climate conditions, the sections of your home being insulated and the kinds of materials used in your home's construction. The recommendations shown here are for a typical Iowa home.

Check this R-value guide for the optimal insulation levels for your home

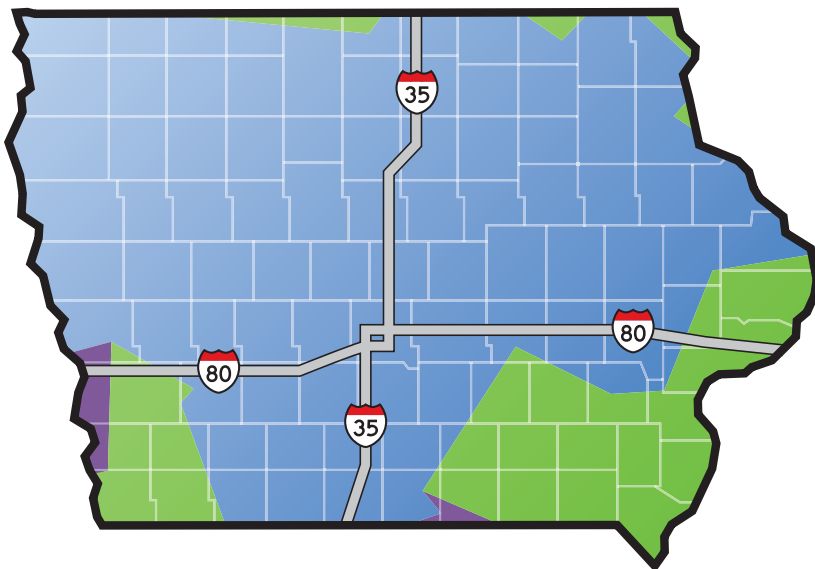

Zone	1	1	2	2	3
Gas	✓		✓		✓
Heat pump	✓		✓		✓
Fuel oil	✓		✓		✓
Electric furnace		✓		✓	✓
Ceiling/Attic	R-49	R-49	R-49	R-49	R-49
Ceiling/Cathedral	R-38	R-60	R-38	R-38	R-38
Wall	R-18	R-28	R-18	R-22	R-18
Floor	R-25	R-25	R-25	R-25	R-25
Crawl space	R-19	R-19	R-19	R-19	R-19
Slab edge	R-8	R-8	R-8	R-8	R-8
Basement/ Interior	R-11	R-19	R-11	R-19	R-11
Basement/ Exterior	R-10	R-15	R-10	R-15	R-10

Source: U.S. Department of Energy Office of Energy Efficiency and Renewable Energy

Insulation is rated by R-values

The **R-value** (or thermal resistance) of insulation is a measure of its ability to resist heat loss or heat gain. The higher the R-value, the better a material insulates.

It's important to note that an insulation's R-value is based on its performance in a 70°F environment with no air movement. Ironically, those ideal conditions are *not* when you need insulation the most!

Therefore, the *rated R-value* from the insulation's manufacturer may be much higher than its *effective R-value* if the insulation is not properly installed—or air leaks are not plugged before the insulation is added. Some types of insulation—such as blown-in wet cellulose, polyurethane and polycynene—combine both air sealing and insulation in one step. The rated and effective R-values for these products are very similar, and they have a good performance record when installed correctly.

When you go shopping for insulation, it's important to remember that the product with the highest R-value per inch may not be the most cost-effective one. For example, when insulating a basement wall to an R-12 value, using 3 inches of an R-4 per inch insulation material might be less expensive than using 2 inches of an R-6 per inch product. To get the most insulating value for your money, compare the total costs of insulating an area to a specific R-value.

In addition, some materials may settle after installation, reducing their effective R-value by 10 percent or more. Be sure to check the manufacturer's specifications before you buy insulation.

CAUTION!

When you're insulating or sealing air leaks in the attic, be careful not to step on wires or wiring devices such as ceiling boxes or recessed lighting fixtures. Turn off the power to those devices at the circuit breaker box or fuse box before you start. Follow manufacturer's recommendations for insulating around lighting fixtures.

CAUTION!

Check local building codes before starting an insulation project at your home.

? Did you know?

Trying to plug an air leak with fiberglass insulation won't work very well, because the material is not a good air barrier. Instead, use solid materials such as caulking, spray foam, drywall, plywood or rigid foam to stop air infiltration.

Types of insulation

Blankets: batts or rolls

Material	Fiberglass, rock wool and natural fibers
Method of installation	Fitted between studs, joists and beams
Where applicable	All unfinished walls, floors and ceilings
Advantages	Do-it-yourself. Suited for standard stud and joist spacing, which is relatively free from obstructions.

Loose-fill

Material	Rock wool, fiberglass, cellulose and natural fibers, polyurethane and polycynene
Method of installation	Blown into place or spray-applied with special equipment
Where applicable	Enclosed existing wall cavities or open new wall cavities. Unfinished attic floors and hard-to-reach places.
Advantages	Commonly used for retrofits (adding insulation to existing finished areas). Good for irregularly shaped areas and around obstructions.

Sprayed foam and foamed-in-place

Material	Polyisocyanurate and polyurethane
Method of installation	Small spray containers or in larger quantities as a pressure-sprayed (foamed-in-place) product
Where applicable	Enclosed existing wall or open new wall cavities; unfinished attic floors
Advantages	Adding insulation to existing finished areas, irregularly shaped areas and around obstructions

Rigid foam

Material	Extruded polystyrene foam (XPS), expanded polystyrene foam (EPS or beadboard), polyurethane foam and polyisocyanurate foam
Method of installation	Interior applications—must be covered with 1/2-inch gypsum board or other building-code approved material for fire safety. Exterior applications—must be covered with weatherproof facing.
Where applicable	Basement walls, exterior walls under finish materials and unvented low-slope roofs
Advantages	High insulating value for relatively little thickness. Can block thermal leak when installed continuously over frames or joists.

Reflective

Material	Foil-faced kraft paper, plastic film, polyethylene bubbles or cardboard
Method of installation	Fitted between wood-frame studs, joists and beams
Where applicable	Unfinished floors, walls and ceilings
Advantages	Do-it-yourself. All are suitable for framing at standard spacing. Use bubble-style if framing is irregular or obstructions are present.

Structural insulated panels

Material	Foam board, liquid foam core and straw core
Method of installation	Builders connect them together to construct a house.
Where applicable	Unfinished floors, walls and ceilings for new construction
Advantages	Superior and uniform insulation compared to more traditional construction methods; also take less time to build.

Insulating concrete forms

Material	Foam boards or foam blocks
Method of installation	Installed as part of the building structure
Where applicable	Unfinished walls—including foundation walls—for new construction
Advantages	Literally built into home's walls as part of sandwiched concrete-foam system, creating high thermal resistance.

CAUTION!

Vermiculite insulation was commonly used in homes built before 1950. Vermiculite insulation isn't used today, because naturally occurring asbestos has been discovered in some vermiculite products.

Only a few sources of vermiculite have been found to contain more than tiny trace amounts of asbestos, according to the U.S. Environmental Protection Agency. Still, if you have vermiculite insulation in your attic, don't disturb it. If you want to add insulation to your attic, call an insulation contractor who is trained and certified in handling asbestos.

How much insulation do you already have?

Even if your home is only eight to 10 years old, it may not have enough insulation in the attic and walls—or under the floors. If you live in a much older home, it's pretty likely that adding more insulation will help reduce your heating and cooling bills.

- ▶ Look in the attic. Use this chart to figure out what kind of insulation you have and what its R-value is. Then measure the insulation's depth and multiply it by the factor shown to estimate the R-value.

What you see		What it probably is	Depth (inches)	Total R-value
Loose fibers	Lightweight yellow, pink or white	Fiberglass	_____	= 2.5 x depth
	Dense gray or near-white, may have black specks	Rock wool	_____	= 2.8 x depth
	Small gray flat pieces or fibers (from newsprint)	Cellulose	_____	= 3.7 x depth
Granules	Lightweight (various colors)	Vermiculite or perlite	_____	= 2.7 x depth
Batts	Lightweight yellow, pink or white	Fiberglass	_____	= 3.2 x depth

continued on page 18

continued from page 17

New attic insulation

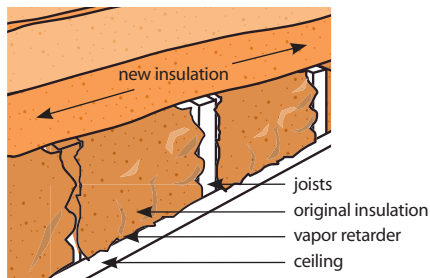

When you add insulation to your attic, run the new batts perpendicular to the direction of the ceiling joists to cover air gaps that may have developed in the existing insulation along the joists.

? Did you know?

If you are building a new home, make sure a proper vapor retarder is installed under the concrete slab.

- ▶ Look into the walls. It's pretty difficult to add insulation to existing walls, unless you're planning to add new siding to your home or finish an unfinished space. However, there are insulating methods (usually handled by a professional insulating contractor) that can bring the R-value up to the appropriate level.
- ▶ One method of determining if exterior walls are insulated is to check around electrical outlets in the walls. (Be sure to turn off the power first!) Remove the cover plates and shine a flashlight into the crack around each outlet box; you should be able to see whether or not insulation is in the wall. Be sure to check separate outlets on the first and second floors—and in old and new parts of the house—because wall insulation in one wall doesn't necessarily mean that it's in all walls.

If you can't see insulation around the outlets, remove a section of baseboard molding or paneling to expose an exterior wall cavity, cut a hole in the wall of a closet or cabinet that faces an outside wall, go to the attic and look down openings in the top plates of exterior walls or take out a small section of exterior siding.

- ▶ Look under floors. Check the underside of any floor over an unheated space such as a garage, basement or crawlspace. Inspect and measure the thickness of the insulation you find there. It most likely will be fiberglass batts, so multiply the thickness in inches by 3.2 to find out the R-value. If the insulation is a foam board or sprayed-on foam, use any visible label information or multiply the thickness in inches by 5 to estimate the R-value.

To determine the most economical insulation levels for your home, go to the U.S. Department of Energy Web site at <http://www.ornl.gov/~roofs/Zip/ZipHome.html> and fill out the **ZIP-Code Insulation Program** form.

Insulation needs a vapor retarder

As you've seen with a glass of ice water, condensation occurs when warm, moist air touches a cold surface. When this happens in your home, it can cause water or frost damage, mold and mildew.

A **vapor retarder** slows the movement of air and water vapor through building materials; in fact, a good vapor retarder will allow very little moisture to pass through. When you go shopping for a vapor retarder, you may find it mislabeled as a *vapor barrier*.

Whenever you install insulation in an uninsulated area, always include a vapor retarder. If you're adding insulation to an area that already has a vapor retarder, you don't need to add another one. Vapor retarders generally fall into these categories:

- ▶ *Foil*, a synthetic material or kraft paper often is part of fiberglass batt or blanket insulation. The vapor retarder should face the warm side of a ceiling, wall or floor surface.
- ▶ *Rigid board insulation* acts as a vapor retarder when installed under an interior covering material such as drywall. The seams of rigid foam board should be taped—for both interior and exterior use—to improve its performance. This will help prevent moisture condensation problems, because the foam keeps the temperature in the wall cavity above the dew point temperature.
- ▶ *Sprayed-in materials* such as polyurethane and polycynene insulation may not need a vapor retarder when installed properly. Check your local building codes for vapor retarder requirements.
- ▶ *Polyethylene sheets* are not a good choice if you have central air-conditioning; the material can trap hot, humid air inside your home.

From top to bottom, here are some things to know about insulating your home

Start in the attic

Because your home can lose a significant amount of heat through the roof, the best place to begin insulating is the attic. This usually is the easiest place for “do-it-yourselfers” to begin, because access is good and you can install loose-fill, batt or blanket insulation over existing insulation. If you choose to use a blown-in insulation such as wet cellulose, polyurethane or polycynene, you’ll need to have it professionally installed.

What about open ceilings or flat roofs?

Insulating a cathedral ceiling, A-frame house or flat roof is an especially difficult job, because there is little or no space between the ceiling and roof. With these types of ceilings, professional installation of spray-in insulation materials is recommended.

Insulated ceiling panels are another possible solution; the panels are made from insulation batts covered with a vapor retarder.

Another solution is to build a wooden framework to hold the insulation, which is installed against the ceiling and covered with a vapor retarder and new drywall. Ventilation of the space between the cathedral and new dropped ceiling may be necessary to avoid condensation.

Head for the basement

Most Iowa homes have basements with either concrete block or poured-concrete walls. While such walls make sturdy foundations, they’re poor insulators and have a very low R-value. As a result, an uninsulated basement can account for a significant amount of a home’s total heat loss.

Before you begin any insulation projects in the basement, **check for moisture problems and air leaks**. You can repair minor problems on the inside of the foundation wall with sealant or waterproofing compounds, but any serious water leaks will require more extensive repairs. In addition, make sure downspouts are in good shape and the ground around the foundation slopes away from the house to ensure that water drains away from it.

If you don’t correct these problems before insulating—or don’t install a proper vapor retarder—you may cause **mold problems** in your basement.

Check the top of the basement foundation

The wood joists and other building materials offer only token resistance to heat flow from your basement. The **band joist** area (where the wood structure of the house rests on the concrete foundation) is the best place to begin. It’s the simplest and least expensive basement area to insulate, and it will bring you the highest return on your investment. Insulate it to R-19.

Then do the basement walls

Insulating the **interior** of your basement’s perimeter walls (using batts or blankets) usually is less expensive and less involved than insulating the outside of the perimeter walls. Although the techniques necessary for building new stud walls around the perimeter require some carpentry skills, they generally are within the skills of the average do-it-yourselfer. Before beginning, check your local fire code for special insulation requirements.

Exterior foundation insulation usually is done during construction; on an existing home, it’s a job for a professional. Rigid panel insulation is glued to the exterior wall of the basement. Above ground level, the insulation is covered with cement board or pressure-treated plywood to protect the insulation, and both are secured to the foundation.

CAUTION!

Whenever you’re in the attic looking for air leaks, working around existing insulation or installing new batts, blankets or loose-fill products, change into a long-sleeved shirt and long pants or a disposable protective jumpsuit. Prevent eye and skin irritation with safety goggles, a respirator and nitrile gloves too.



Did you know?

Do not cover or hand-pack insulation around bare heating system or gas water heater vents, stove pipes, electric motors, recessed lighting fixtures not labeled for direct contact with insulation or any other heat-producing equipment. If you pack insulation in these areas, heat can build up and start a fire.

Insulate along band joists

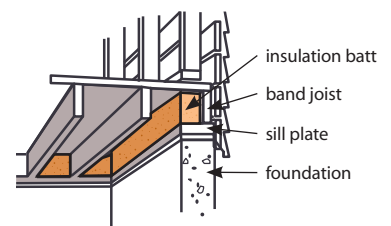

Cut insulation to fit band joist spaces between the sill and subfloor.

Use batts in cantilevered spaces

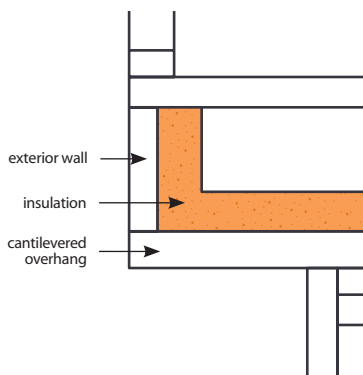

Insulate under bay windows and other cantilevered spaces.

CAUTION!

Crawl spaces may require special attention for moisture-related issues. Consult a building professional if you suspect any problems, and fix them before you insulate.

A job for a professional



Although you may be able to rent the equipment for blowing insulation into your home's exterior walls, the job is very involved and is best handled by an experienced insulation contractor.

Insulate floors over unheated spaces

Floors over a basement that has a heat source such as a furnace, boiler or wood stove don't need to be insulated. However, floors over an unheated area such as a garage, a porch or open ground can be a source of considerable heat loss.

- ▶ A cantilevered floor over an exterior wall needs insulation just as much as a floor over an unheated basement, because it's exposed directly to the outside and may have many air leaks that cause drafts. Depending on how the floor is built, there are a few ways to make cantilevered floors more comfortable. One way is to hire a professional to spray in polyurethane or polycyrene insulation. If you choose to insulate this area yourself, use R-19 batts with a vapor retarder facing up, toward the heated part of the house.
- ▶ Insulate the floor in a mobile home or a home supported by piers to R-19 or higher. Cover the ground and the batts or blankets to protect against moisture, wind and animals.
- ▶ If your home was constructed slab-on-grade, the cold slab can damage wood and carpets if water and ice condense on the floor. During construction, rigid board insulation should have been installed around the entire perimeter of the slab. If not, a professional can insulate the slab using rigid insulation board with plywood flooring on top.
- ▶ Use rigid board insulation or spray-in foam to insulate the "floor" of a bay window projection or other cantilevered spaces.

If you have a crawl space ...

Insulate crawl space foundation walls and the floor to a value of R-10 or higher. If your crawl space has a dirt floor, cover it with polyethylene sheeting and extend the plastic several inches up the walls before insulating. See page 22 for tips on properly ventilating a crawl space.

When should you add wall insulation?

Insulating the walls of an existing home is difficult and generally should be done by a professional insulating contractor. Because of the high cost of blowing insulation into exterior walls, consider this job only after your home has been thoroughly tightened and the attic and basement or crawl space have been insulated.

Insulating your walls is a good idea when there is less than one inch of insulation in the wall cavities. (Typically, walls have space for 3 1/2 inches of insulation.) If you already have some insulation there, however, the cost of adding more insulation may outweigh the benefits.

One time it makes sense to consider insulating your walls is when replacing your home's siding. Insulation can be blown into empty stud cavities before the new siding is installed; another option is to install foam board insulation under the new siding.

As an alternative, if you're planning an extensive interior renovation—to the point of gutting the interior walls of your home—fill the wall cavities with insulation as long as they're already open.

If you decide to insulate your walls, obtain bids from several contractors and compare the R-values provided, as well as the cost to complete the job. Walls should be insulated to a level of R-18 or more with blown-in, loose-fill or spray-in insulation. (See chart on page 15.)

Keep heated and cooled air in your ducts

The **ductwork** for a forced-air heating and air-conditioning system can be one of your home's biggest energy wasters—especially if those ducts run through unheated or uncooled spaces.

- ▶ Check the ducts for air leaks. Repair leaking joints first with sheet-metal screws; then seal remaining leaks with latex-based mastic and embedded fiberglass mesh or mastic or aluminum tape. Don't use plastic or cloth duct tape because it will harden, crack and lose its adhesion in a very short time.
- ▶ Wrap the ducts with duct wrap insulation rated at least R-6, with the vapor retarder facing out. All joints where sections of insulation meet should have overlapped facings and be tightly sealed with fiberglass tape. Avoid compressing the insulation, which will reduce its thickness and R-value.
- ▶ To make sure some of the warmed or cooled air in the ducts is not blowing into walls or under floors, seal all registers and grills tightly to the ducts.
- ▶ When you're finished working, install a new air filter to catch any dust and debris you may have knocked loose while insulating or repairing the ducts. Check the filter a couple of days later to make sure it doesn't need to be changed again.
- ▶ Make sure ducts fit tightly to the register openings in floors and walls; if they don't, seal the joints with caulk.
- ▶ Seal return duct joints, too, so you won't be breathing basement or crawl space air.

Insulate your pipes

The longer they run through unheated spaces, the faster the hot water pipes from your water heater or hydronic heating system will cool, causing these systems to work harder than necessary to meet your family's needs. Use inexpensive foam insulation sleeves from your hardware store or home center to insulate these pipes; secure the insulation with duct tape.

For boilers and steam heating system pipes, use insulation with a high enough temperature rating so it won't melt.

Check your doors and windows too

While you might not think of exterior doors and windows as being part of your home's insulation system, they're certainly an integral part of your home's protective envelope.

- ▶ If you don't properly maintain the finish on a wood exterior door, it can absorb moisture and warp. A solid-core wood door is a good insulator, but it's not as good an insulator as a steel or fiberglass door with a foam core. An insulated steel door with refrigerator-type magnetic weather stripping is the best choice for energy efficiency.
- ▶ New high-efficiency doors and windows can contribute to saving a considerable amount of energy if installed properly. One key to maintaining their efficiency is sealing the edges where they meet the surrounding walls, so air and moisture can't enter your home. Pay close attention to the hidden joints where each door or window meets the wall framing, as well as the visible seams at the siding. Fill large, hidden gaps with liquid urethane insulating foam from a spray can or with fiberglass insulation. Also run a bead of high-quality caulk at the surface of each joint, and paint it to match.
- ▶ Decrease the heat loss from windows during cold-weather months with insulating window treatments such as heavy draperies, insulating panels and pop-in shutters with a rigid foam insulation core and quilted roller shades and Roman shades with several layers of fiber batting. Close window coverings in rooms that don't receive sunlight during the day, and close all of them at night. When warm weather arrives, use light-colored window treatments to reflect the sun's heat away from windows. For year-round use, choose dual-surface shades—they're reflective white on one side and heat-absorbing dark on the other side—so you can reverse them with the seasons.

Seal and insulate ducts

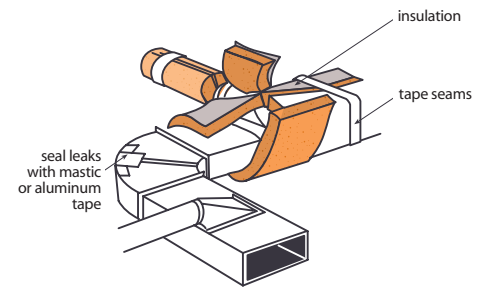

Tighten and seal leaky ducts before insulating with foil- or paper-faced batts made especially for ducts.

Insulate pipes

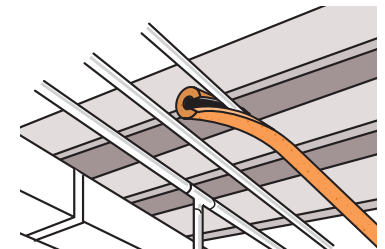

Use foam insulation on hot water pipes in your basement or crawl space. The water will stay warmer in the pipes, cutting the time you need to wait for hot water for sinks, bathtubs or showers.

Save hot water

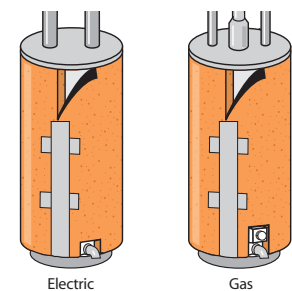

Giving your older water heater a blanket to lower your water-heating bills is an easy, do-it-yourself job. Be sure to follow the insulation manufacturer's installation instructions—the process differs for electric and gas water heaters. Note that new water heaters have adequate insulation, so their manufacturers recommend not adding an insulating blanket.

Ventilation

Did you know?

A power attic ventilator can rob your home of warmed air in the winter or cooled air in the summer, if your attic doesn't have adequate ventilation.

CAUTION!

Call a professional to install a whole-house fan or power attic ventilator.

Continuous ridge vent

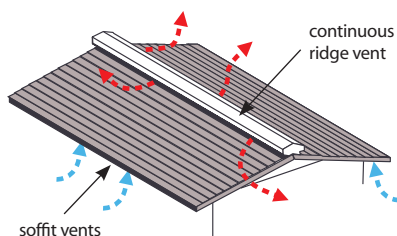

If you're reroofing or building a new home, a continuous ridge vent combined with soffit vents offers optimal attic ventilation. In this illustration, blue arrows indicate outside air flowing into the attic and red arrows show attic air flowing out.

A healthy, energy-efficient home needs to breathe

Proper ventilation is important to protect your home from moisture damage during the winter and to reduce heat buildup during the summer.

Even if your home is very tight, some moisture will travel to the attic, where it can cause a lot of damage if it's not vented outdoors; you'll see problems such as wet insulation (which is ineffective), water stains on your ceilings and ice dams on the roof during the winter.

Your home needs at least two ventilation sources for circulating air through the attic. Vents high—at or near the top of the roof—and low—at the lower edge of the roof—let air circulate naturally.

At the top of the roof, you can use continuous ridge vents, static roof vents, gable end vents or wind-driven turbines. At the lower edge of the roof, install continuous soffit vents or several single vents in the roof overhang; make sure these vents aren't blocked by attic insulation and allow air to circulate naturally.

Attics with a ceiling vapor retarder should have a minimum of one square foot of vent area for every 300 square feet of ceiling area. If your ceiling doesn't have a vapor retarder, your attic needs twice the amount of vent area, or one square foot for every 150 square feet of ceiling area. (See page 18 for vapor retarder information.)

Good natural ventilation makes a power ventilator unnecessary for most homes. However, if you can't get enough air flowing through your attic on its own, a *power attic ventilator* is an effective, but expensive, solution to solve moisture problems and to cool an attic. The best place for a power attic ventilator is near the top of the roof on the side facing away from the prevailing winds. During the winter, a humidistat starts the fan to remove moisture from the attic; during the summer, a thermostat starts the fan when the attic gets too hot.

Here are a few more home-ventilating tips

While keeping the air moving through your attic is the largest ventilation issue in your home, there are some other things you can do to promote proper ventilation throughout your home.

- ▶ A *basement* usually doesn't need to be ventilated, but a crawl space containing water pipes or other utilities does (unless it's insulated). Install vents that can be opened in the summer and closed tightly in the winter to reduce heat loss. You'll need about one square foot of vent for every 150 square feet of floor in your crawl space. Vents at each corner of the crawl space provide the best air circulation.
- ▶ A *whole-house fan* can be a good substitute for air-conditioning, reducing indoor temperatures by several degrees. All you do is open your home's windows during the evenings on warm-weather months and start the fan to draw cool air into your home and expel warm air into your attic and out the attic vents; you can expect lower air-conditioning costs through the prudent use of this energy-saving system.
- ▶ Install an *exhaust fan* in each bathroom to remove moisture from showers or steamy baths, as well as putting one in the kitchen to vent moisture and cooking smells. Note that exhaust fans remove heated or cooled air as well as moisture and odors, so use them only when needed. When you go shopping, make sure the fans you buy are properly sized for the rooms in which they're located and their planned usage. During installation, make sure the fans are vented outdoors instead of the attic. Otherwise, the fans will dump excess moisture into the attic, which could dampen the surrounding insulation and render it ineffective.

For your safety, try a carbon monoxide detector

Because carbon monoxide (CO) can't be detected in any other way, buy at least one battery-powered CO alarm or an AC-powered unit with a battery backup for each level of your home and near sleeping areas. Other beneficial features include a digital display, which allows you to see both the level of CO as soon as it's present and the memory of the peak level. This information lets emergency personnel know how high the level was—and how to treat victims of CO poisoning.

Follow the manufacturer's directions for placement, installation and replacement of the CO alarm, and make sure you test it monthly. Also change its battery once a year—an easy-to-remember time is when you set back your clocks from daylight saving time every fall. This also is a good time to change the batteries in your smoke alarms, emergency radio and flashlights, so you'll be prepared if a severe storm causes a power outage in your area.

Finally, note that a CO alarm won't last forever; it needs to be replaced after approximately seven years. Check the unit's instruction manual for details, or look for a sticker with a replacement due date on the bottom of the device.

Can your home be too tight?

Tightening up your home with caulking and weather stripping, installing insulation and sealing ducts to reduce energy costs will have a significant effect on the way your home operates, as well as your comfort. However, it is possible to get your home too tight, causing it to trap stale air and moisture inside. One sign that you do not have enough ventilation in your home is the appearance of **condensation** on walls, attics or crawl spaces.

In extreme cases, your fuel-burning appliances—such as the gas furnace, water heater and stove—can use more than their fair share of the air in your home for combustion, creating a **negative air pressure** inside and causing the appliances to back-draft. This can lead to a number of problems—including CO poisoning and even death. The same thing can happen if you have a wood-burning stove, a fireplace or an attached garage where you let your car idle to “warm up.”

The smart thing to do is to have a blower door test performed after you've completed all your energy-saving improvements to check the amount of fresh air coming into your home. If it's not sufficient for healthy living, you can add an **air-to-air heat exchanger** to your heating and cooling system to bring in fresh air. In addition, hire a technician to check your furnace and water heater flues to make sure they're drawing properly and sending combustion byproducts up their flues and out of your home. If they're not working properly, you may need to have the technician add a fresh-air intake to these devices.

In the future—when you're replacing the heating units in your home—choose a direct-vented sealed combustion furnace or consider installing an electric unit such as a ground-source heat pump.

? Did you know?

When a CO alarm sounds in your home, never ignore it. Get your family out of the house immediately, and open the windows to allow the CO to dissipate. Call emergency personnel from a neighbor's home or a cell phone once you're out of the house.

Test your CO alarm monthly

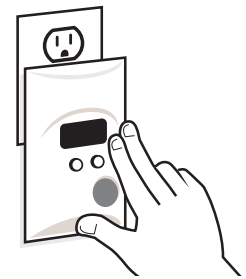

The best type of CO detector to buy is one that plugs into an outlet and has a backup battery.

CAUTION!

To protect your family from carbon monoxide (CO) poisoning, have all fuel-burning heating appliances checked by a qualified heating contractor every year. And be on the alert for these signs of carbon monoxide poisoning:

- ▶ Your entire family is sick at the same time with flu-like symptoms such as headaches, nausea, fatigue and dizziness.
- ▶ Flu-like symptoms decrease when you're away from home.
- ▶ Illness is present when gas appliances are in use.
- ▶ Excess moisture appears on the inside of windows.

Alliance to Save Energy

1850 M Street, NW, Suite 600
Washington, DC 20036
Phone: 202-857-0666
Web site: <http://www.ase.org/>

Alliant Energy

4902 North Biltmore Lane
P.O. Box 77007
Madison, WI 53707-1007
Phone: 800-255-4268
Web site: <http://www.alliantenergy.com/>

**American Council for an
Energy-Efficient Economy**

529 14th Street, NW, Suite 600
Washington, DC 20045-1000
Phone: 202-507-4000
Fax: 202-429-2248
Web site: <http://www.aceee.org/>

Atmos Energy Corporation

2547 Hilton Road
Keokuk, IA 52632
Phone: 888-286-6700
Web site: <http://www.atmosenergy.com/>

Black Hills Energy

625 9th Street
Rapid City, SD 57709
Phone: 888-890-5554
Web site: <http://www.blackhillsenergy.com/>

Energy Efficient Rehab Advisor

Web site: <http://rehabadvisor.pathnet.org/>

ENERGY STAR®

1200 Pennsylvania Avenue, NW
Washington, DC 20460
Phone: 888-782-7937
Web site: <http://www.energystar.gov/>

Federal Trade Commission (FTC)

Consumer Response Center
600 Pennsylvania Avenue, NW
Washington, DC 20580
Phone: 877-382-4357
Web site: <http://www.ftc.gov/>

**Gas Appliance Manufacturers
Association (GAMA)**

2107 Wilson Boulevard, Suite 600
Arlington, VA 22201
Phone: 703-525-7060
Web site: <http://www.gamanet.org/>

Home Energy Saver

Environmental Energy Technologies Division
at the Lawrence Berkeley National Laboratory
Web site: <http://hes.lbl.gov/>

IowaENERGY.org

Web site: <http://www.iowaenergy.org/>

Iowa Association of Electric Cooperatives

8525 Douglas, Suite 48
Des Moines, IA 50322-2992
Phone: 515-276-5350
Fax: 515-276-7946
Web site: <http://www.iowarec.org/>

**Iowa Department of Human Rights/
Division of Community Action Agencies**

Lucas State Office Building
321 E. 12th Street
Des Moines, IA 50319
Phone: 515-281-3861
Fax: 515-242-6119
Web site: <http://www.state.ia.us/government/dhr/caa/>

Iowa Association of Municipal Utilities

1735 NE 70th Avenue
Ankeny, IA 50021-9353
Phone: 515-289-1999 or 800-810-4268
Fax: 515-289-2499
Web site: <http://www.iamu.org/>

Iowa Department of Natural Resources

502 E. 9th Street
Des Moines, IA 50319-0034
Phone: 515-281-5918
Web site: <http://www.iowadnr.gov/>

Iowa Office of Energy Independence

Lucas State Office Building
312 E. 12th Street
Des Moines, IA 50319
Phone: 515-281-0187
Web site: <http://www.energy.iowa.gov/>

Iowa Renewable Energy Association

P.O. Box 3405
Iowa City, IA 52244-3405
Phone: 319-643-3160
Web site: <http://www.irenew.org/>

Iowa State University Extension

Answer Line Phone: 800-262-3804
Web site: <http://www.extension.iastate.edu/answerline/>
or <http://www.extension.iastate.edu/housing/>

MidAmerican Energy

666 Grand Avenue, Suite 500
Des Moines, IA 50309-2580
Phone: 888-427-5632
Web site: <http://www.midamericanenergy.com/>

**U.S. Department of Energy Office of
Energy Efficiency and Renewable Energy**

Forrestal Building
U.S. Department of Energy
1000 Independence Avenue, SW
Washington, DC 20585
Phone: 877-337-3463
Web site: <http://www.eere.energy.gov/>

U.S. Environmental Protection Agency

Ariel Rios Building
1200 Pennsylvania Avenue, NW
Washington, DC 20004
Phone: 202-272-0167
Web site: <http://www.epa.gov/>



This is an Iowa Energy Center publication.

The Iowa Energy Center is a research, demonstration and education organization dedicated to improving Iowa's energy efficiency and use of renewable energy. The Energy Center meets its goals by developing in-house energy research and education programs and by sponsoring energy projects developed by other groups. The projects supported by the Energy Center, which vary in size and complexity, are conducted throughout the state in Iowa's universities, colleges, community colleges and private nonprofit organizations.

Iowa Energy Center

2521 University Boulevard, Suite 124, Ames, IA 50010-8629
Phone: 515-294-8819 | Fax: 515-294-9912 | E-mail: iec@energy.iastate.edu
Web site: <http://www.energy.iastate.edu>



Home Heating and Cooling

2



- 🏠 **Reduce your utility bills** with low-cost, low-tech tips
- 🏠 **Get more heat** from every energy dollar you spend—page 3
- 🏠 **Make the most** of your air-conditioning system—page 10
- 🏠 **Landscape your yard** for year-round comfort—page 19

Save with a whole-house approach

Did you know?

The **Energy Independence and Security Act of 2007** sets the stage for significant changes in energy policy across the United States for many years to come. During the next several years, new energy-efficiency standards will be put into place for appliances, furnace motors, residential boilers and other energy-using devices. So, watch for the latest news about tax credits for homeowners who make energy-saving improvements to their homes at the Web site of the Tax Incentives Assistance Project (TIAP) at <http://www.energytaxincentives.org/>.

Every year, a typical family in the United States spends around half of its home energy budget on heating and cooling. In Iowa, that percentage can be higher, due to temperature extremes reached during the winter and summer months. Unfortunately, many of those dollars often are wasted, because conditioned air escapes through leaky ceilings, walls and foundations—or flows through inadequately insulated attics, exterior walls and basements. In addition, many heating systems and air conditioners aren't properly maintained or are more than 10 years old and very inefficient, compared to models being sold today.

As a result, it makes sense to analyze your home as a collection of systems that must work together in order to achieve peak energy savings. For example, you won't get anywhere near the savings you're expecting from a new furnace if your air-handling ducts are uninsulated and leak at every joint. The most energy-efficient central air-conditioning setup won't perform to your expectations if your attic insulation is inadequate and can't reduce solar heat gain to help keep your home cool. And planting the wrong types of trees or shrubs close to your home adversely can affect potential energy savings all year long.

Here's the bottom line

By properly maintaining your existing heating and cooling equipment (or replacing aging units with high-efficiency models), addressing weatherization and insulation issues at your house and getting into the habit of using energy efficiently all the time, you can save **10 to 30 percent (or more)** on your utility bills every year. You'll also help **reduce pollution** at utility plants that use fossil fuels to generate electricity. (According to the U.S. Department of Energy, the electricity generated by fossil fuels for a single home creates more carbon dioxide than two average-sized cars.)

How much of the work can you do?

If you're a competent do-it-yourselfer, you can handle many of the maintenance chores and energy-saving projects described in this book. However, if you're uncomfortable with the idea of working around electricity or would rather hire someone to handle a job, don't hesitate to call a professional; the dollars saved through energy savings in future years will be worth the expense. (Of course, only a trained technician should handle jobs that require working with refrigerants or control units.) For details on hiring a heating and cooling contractor, see page 23.

Your utility or bank might be able to help with project costs

Small energy-efficiency projects such as sealing air leaks or weather-stripping windows are relatively inexpensive. However, when it's time to purchase a new heating and cooling system, it makes sense to talk with your utility company and bank before buying. Some utility companies, for example, offer **rebates** on high-efficiency air-source heat pumps, geothermal heat pumps, gas furnaces, boilers and central air-conditioning systems.

Ask a banker about a **low-interest loan** to cover the cost of your energy-saving projects, or consider a **home-improvement loan**. If you're planning to refinance your home mortgage, look for an **energy-efficiency mortgage** that allows a lender to use a higher-than-normal debt-to-income ratio to qualify you for the loan.

Finally, check for government-sponsored assistance and grant programs designed for low-income and elderly homeowners. Get in touch with a Community Action Agency in your area, or see page 24 for information on contacting the Iowa Department of Human Rights/Division of Community Action Agencies.

Energy use in a typical home

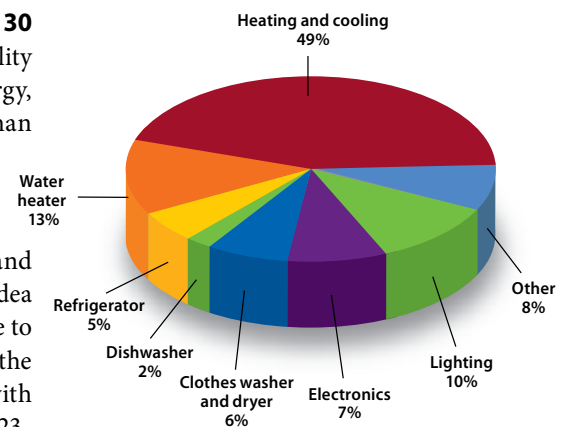

Across the country, heating and cooling an average home consumes almost as much power as all other energy uses combined. The "Other" category includes a variety of household products such as stoves, ovens, microwaves and small appliances.

Source: ENERGY STAR®

Heating

Lower energy consumption means lower costs

No matter what kind of equipment heats your home, one thing is certain: The more energy-efficient the heating system is, the lower your utility bills will be. Using less energy also is good for the environment, because doing so reduces air pollution and helps conserve natural resources. In fact, according to the U.S. Department of Energy, the combination of a tight, well-insulated home, a properly maintained, high-efficiency heating system and reasonable thermostat settings can **cut both your heating bill and your pollution output in half.**

Is it time for a change?

If you've lived in your home for several years—and the heating system was in place when you bought the house—it may be hard for you to determine if you've gotten your money's worth out of your current equipment. But consider this: ENERGY STAR® recommends replacing a furnace or boiler that's more than 15 years old (or a heat pump or air conditioner that's more than 12 years old) with a new, high-efficiency unit.

Here are some other clues that it's time to go shopping for a new heating system:

- > Your heating bills are going up because the system is using more energy than in past years.
- > The equipment needs to be repaired frequently—often for a different reason each time.
- > Some of the rooms in your house are too hot or too cold, no matter how you adjust the airflow through the ducts.
- > The system just doesn't seem to be working properly, even after a recent service call.
- > The air in your home is exceptionally dry during the heating months.

Unfortunately, you often can't see what causes a heating system to waste energy. Beyond obvious clues such as a sagging duct that blows heated air into the basement, a noisy fan motor on a forced-air furnace or a leaking fuel line on a boiler, most of the energy-wasting problems will be hidden from view.

Make a responsible, long-term choice

Even if you decide to replace your heating system with one of the same type, buy the most energy-efficient unit your budget allows. Although you'll spend a little more money up front, you'll be many dollars ahead in the long run because lower utility bills will shorten the new equipment's payback period.

On the other hand, now may be the perfect time to significantly reduce your family's reliance on conventional energy sources by installing a more efficient heating (and cooling) system. For example, a **geothermal heat pump** (sometimes referred to as a "ground-source" heat pump) can give you up to four dollars of heating (or cooling) for every electrical energy dollar spent. As an alternative, a **passive solar sunspace** can reduce annual heating costs by up to 50 percent (compared to a similar house without passive solar heat), as well as allowing you to install a smaller conventional heating system as a backup for overcast days.

You can have a major impact on reducing heating costs at home

If the time isn't right to replace your heating system, there are a couple of things you can do to keep your home warm and comfortable at an affordable cost with the existing equipment. First, **reduce the heating load** on your home by eliminating air leaks, adding insulation and promoting a change in your family's energy-wasting habits. Second, call a professional heating and cooling contractor to **tune up and optimize the heating system**, including an update of its controls and other internal parts—and adding a programmable thermostat.

In the sections that follow, you'll find many proven low-cost, low-tech methods for saving energy (and money) on your heating needs, in addition to finding out what to consider when upgrading a heating system and maintaining your heating equipment.



Did you know?

On the ENERGY STAR Web site at <http://www.energystar.gov>, you'll find a lot of valuable information in the Home Improvement section. The **Home Energy Yardstick**, for example, takes about five minutes to fill out and will help you discover whether your energy use is above average. The **Remodeling Guide** gives you a list of customized energy improvements (with estimated savings) for different areas of your house. And the **Home Sealing** section offers tips on tightening your home's "envelope" to lower energy bills.

Heating fuels

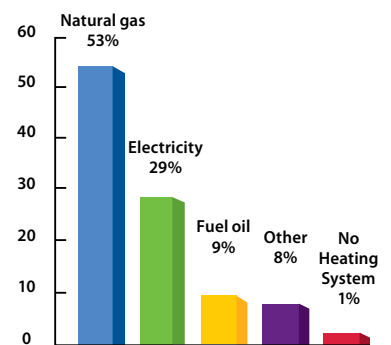

Although there are several different types of fuel available for heating, today more than half of the homes across the country use natural gas.

Source: U.S. Department of Energy Office of Energy Efficiency and Renewable Energy

Make your heating dollars work harder for you

No matter what type of heating system you have, there are some things you can do to **save energy and still stay comfortable at home** during the cold-weather months. Besides calling a professional to check your heating system, try several of the tips in this section to reduce your home's energy usage. Some of these ideas won't cost you a penny—such as opening the curtains on south-facing windows to harvest the sun's warmth during daylight hours—and some may cost a few dollars that you'll recoup within a year through reduced energy bills—such as installing a programmable thermostat. However, they're all worth considering.

From a whole-house perspective, first look for leaks that allow cold air into your home—and heated air out. Then evaluate the insulation levels in your home and add insulation where necessary; attic insulation likely will have the most immediate impact on energy savings, but don't overlook areas such as the foundation, unfinished basement walls and floors above unheated spaces. For more information on improving your home's energy-saving "envelope," ask your utility or the Iowa Energy Center for the book, *Home Series 1: Home Tightening, Insulation and Ventilation*. (See contact list on page 24.)

Survey your home to save

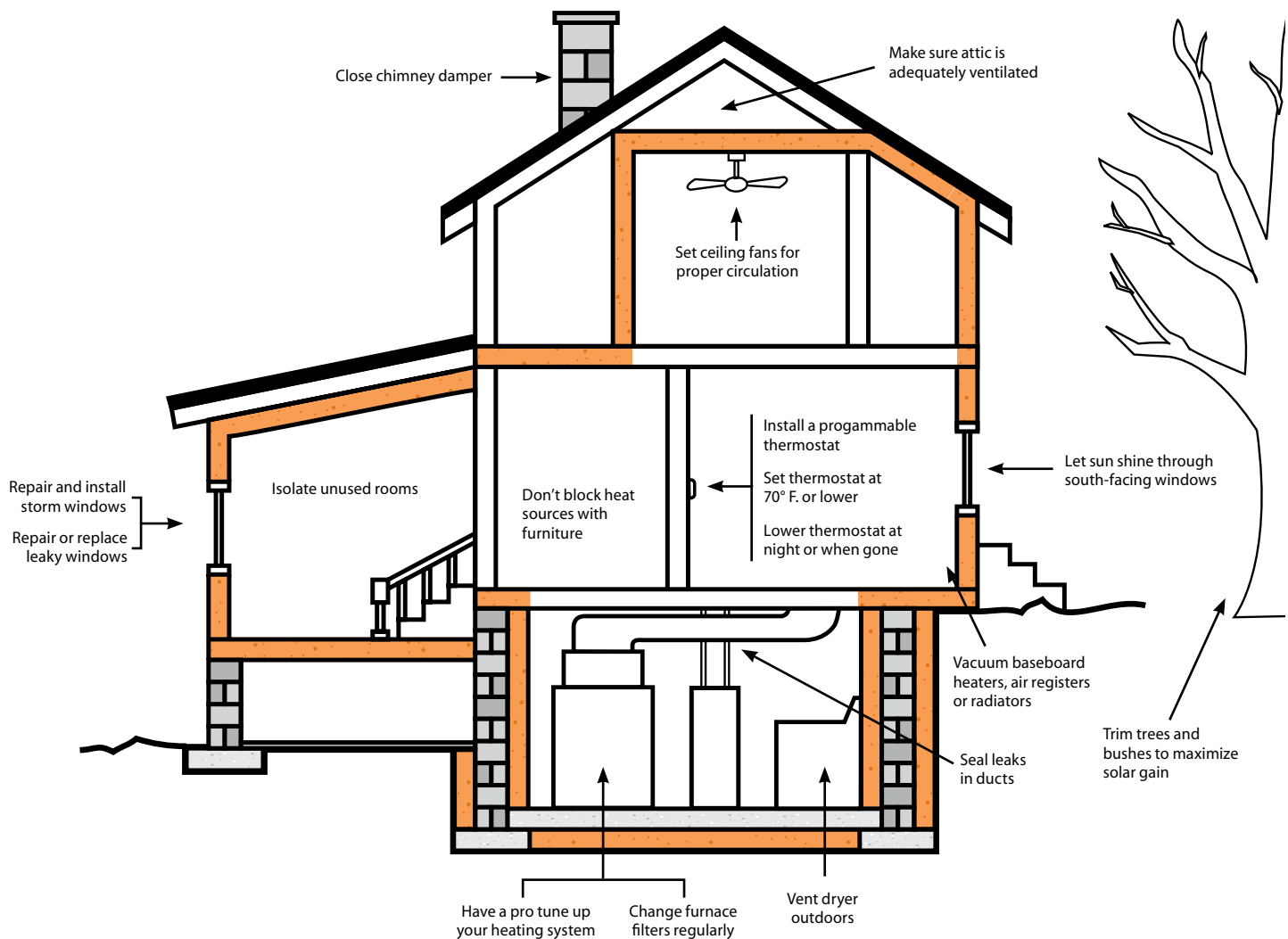

Follow these tips to stay warm

A plan for saving energy during cold weather includes analyzing all the elements that go into heating a home—including the habits of the people who live there. So, in addition to making sure your existing heating system is in peak operating condition (or replacing it with a more energy-efficient unit), talk with family members about how a little effort can yield significant results in cutting heating bills—without adversely affecting anyone's comfort.

Living areas

Walk around your home with this list to discover how many opportunities you have to reduce energy use during the winter. Most of these ideas won't cost anything more than a few minutes of time; the tips that do require a small outlay of cash quickly should pay for themselves through smaller heating bills.

Set the direction of ceiling fans for proper circulation.	Run ceiling fans in a <i>clockwise</i> direction during cold-weather months to move the warm air that gathers near ceilings back into the rooms.
Warm up your bed.	Turn down your thermostat and use extra blankets or quilts—or an electric blanket or mattress pad—to stay toasty at night.
Vacuum baseboard heaters, air registers or radiators.	When you see dust, dirt and lint building up, clean any of these devices that are part of your home's heating system.
Move furniture or window coverings that are blocking air registers, baseboard heaters or radiators.	Make sure all the heated air you're paying for reaches its destination! A blocked air register can cause an adjoining room to overheat, and upholstery or curtains can trap heat between the wall and the fabric—preventing it from being distributed throughout a room.
Install radiator reflectors.	These panels will help reflect heat away from walls and into rooms.
Isolate unused rooms, as long as doing so will not hurt water pipes.	Turn down the thermostat in a room with baseboard heat, or close the registers for a forced-air furnace. However, don't allow temperatures in rooms with water pipes to approach the freezing point.
Remove wall or window air conditioners during cold-weather months.	For a <i>wall unit</i> , cover the opening with a thick plywood panel backed by rigid foam insulation; caulk to ensure the unit is weather-tight. For a <i>window unit</i> , remove it, close the window and fix air leaks. If you can't remove the air conditioner, wrap it in an insulated, waterproof cover made for the job.
Remove humidity from the kitchen and bathroom with a properly sized exhaust fan.	Too much humidity can cause condensation and frost on windows and possibly damage them. But don't leave an exhaust fan on longer—or at a higher speed—than necessary. In one hour, an exhaust fan can blow a "houseful" of heated air outside. In addition make sure these fans are not discharging air and moisture into the attic; they should be vented outdoors.

? Did you know?

Adequate attic ventilation is important during the winter. If air leaks to the attic from the living spaces below aren't adequately sealed, moisture-laden warm air can flow to the attic and freeze in your attic insulation, on the rafters and on the underside of the roof. When the temperature gets above freezing, the ice can melt and run down to your ceilings and walls, damaging them. If moisture buildup in your attic is a problem, check to make sure all existing attic vents are not blocked. If they appear to be okay, look for (and seal) air leaks and consider installing additional attic vents.

Ceiling fan eases temperatures

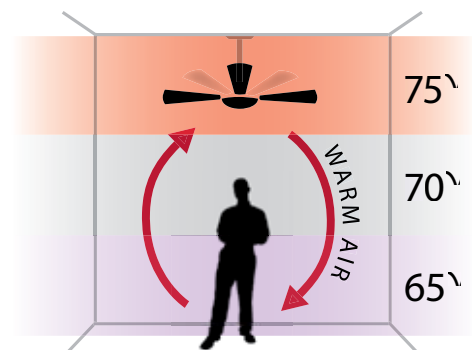

To help eliminate the chilly feeling caused by temperature layering in a room, run your ceiling fan—on the lowest speed, in a clockwise direction—all winter long.

? Did you know?

Furnaces and boilers fueled by natural gas, propane or oil are rated by **AFUE** (Annual Fuel Utilization Efficiency). For heating, air-to-air heat pumps are rated by **HSPF** (Heating Seasonal Performance Factor) and geothermal heat pumps are rated by **COP** (Coefficient of Performance).

Use these numbers to compare units of the same type; in all cases, higher numbers are better. Check with your utility company for recommended minimum ratings, and buy the most efficient unit your budget will allow.

Read the label

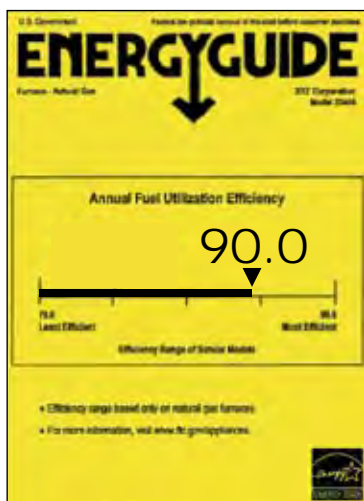

The EnergyGuide label on heating equipment is a summary of the detailed energy-efficiency information manufacturers are required to furnish with their equipment. Compare labels on different units when you shop; higher efficiency numbers indicate lower energy usage and operating costs. Look for the ENERGY STAR logo, too, which means the equipment exceeds federal minimum efficiency standards and uses significantly less energy than a standard unit.

Buying a new heating system

A new heating system is one of the largest investments you'll make in your home, and it's one of the few that actually could pay for itself over a period of several years. Accordingly, it's worth your time to research all the possibilities and "run the numbers" to determine what equipment makes the most sense for your situation.

Ask a pro for help

Talk with several heating and cooling contractors about choosing a system and handling the installation for you. (See page 23 for tips on finding a heating and cooling contractor.)

In some cases, you may be limited by the choices available to you. For example, if you live in an older two-story home that already has radiators in place, it could be very difficult and expensive to install a new duct system for a forced-air furnace instead of a new boiler. However, if you're thinking about making a change—perhaps from a gas forced-air furnace to an air-to-air heat pump or a geothermal heat pump—be sure to ask the contractors to run cost comparisons for the fuels and energy sources available in your area. This is a somewhat complicated process, but there are formulas that make these comparisons possible.

In addition, make sure the contractor **properly sizes** the new heating equipment for your home, using a computer program or calculations based on the Air Conditioning Contractors of America Manual J. This is especially important if you've made recent energy-saving improvements such as sealing air leaks or adding insulation, which may allow you to choose a smaller unit than you presently own. An oversized system (the installation of which was a common practice in poorly weatherized and insulated homes for many years) will cost more initially—and then will waste heating dollars by running in short, inefficient cycles that won't be able to evenly heat all the rooms in your house.

Then consider the **cost to purchase** and the **cost to operate**. For example, compare a new, super-efficient forced-air furnace that costs \$1,200 installed with a no-frills, low-efficiency furnace that costs \$750 installed. Because of its reduced energy usage—and the resulting lower utility bills—the annual operating expense for the more efficient unit might be \$400, while the basic unit might run \$550. The difference in initial cost, \$450, would be paid back during just three years by choosing the more efficient system—and, of course, the savings would continue to accrue for many years to come. Also ask the contractor for **projected repair and maintenance expenses** to factor into your decision-making process.

There really are differences among systems

Buy the most energy-efficient system you can afford, even if you have to stretch the budget a little. Here are some things to consider when evaluating each type of heating system.

Forced-air furnaces

According to ENERGY STAR, about 25 percent of the furnaces in use today are more than 20 years old. Many of these units had efficiencies ranging from 56 to 70 percent, compared to the best systems today that are up to 97 percent efficient. By making energy-saving improvements in your home and upgrading from a 56-percent-efficient furnace to a 90-percent-efficient one, every year you'll **cut heating bills by as much as one-half**—and reduce carbon dioxide emissions by 1.5 tons if you heat with gas and 2.5 tons if you heat with oil.

Look for an AFUE rating over 90 for all types of forced-air furnaces. Gas- and oil-fired units at this level include electronic ignition instead of a continuous pilot light, as well as a sealed combustion chamber that brings fresh outside air to the burner through one pipe and vents exhaust gases outside through another.

Electric resistance

Besides forced-air furnaces, electric resistance heating takes many forms, such as baseboard heaters, cove units or radiant ceiling and floor systems. The energy advantage of these systems is that they allow individual room temperature control, allowing low temperatures in seldom-used rooms and “normal” temperatures in frequently used rooms. In addition, some people prefer non-forced-air options—especially in bathrooms—because they don’t create drafts. For baseboard heaters, choose liquid-filled units that quietly and evenly release heat over a long time period. To save money, ask your utility about special rates for electric heating.

Boilers

Shop for a boiler that features the latest technologies for extracting the most heat from a specified amount of fuel, in addition to including electronic ignition and sealed combustion. If you need to replace radiators or baseboard units, pick ones designed to most effectively heat the space. For new construction or a remodeling project, consider a radiant floor system.

Air-source heat pumps

This system gets its name from the way it uses the difference between the outdoor air temperature and the indoor air temperature to heat (or cool) a home. During the summer, the air-source heat pump functions as an air conditioner; during the winter, it runs in reverse to provide heat. Properly installed and connected to a well-designed (and tight) duct system, an air-source heat pump can deliver up to three units of heating (or cooling) energy for every unit of electric energy it consumes—except in very cold weather, when a backup resistance heating system must supplement the heat pump’s output.

Because it heats and cools, an air-source heat pump is a good choice for replacing an existing heating and cooling system or when you need a new furnace and want to add central air-conditioning. Look for a heat pump with a high HSPF and SEER rating. The best units have a two-stage compressor that runs in a low-power, energy-saving mode most of the time, along with a variable speed blower motor that minimizes noise and energy consumption.

Geothermal (ground source) heat pumps

A geothermal heat pump is the most efficient heating and cooling system available, because it returns up to four dollars of heating (or cooling) energy for one dollar of electricity consumed.

A geothermal heat pump doesn’t burn fuel to create heat; instead, it uses electricity to move heat from the ground through a large loop of buried, fluid-filled pipes to a compressor located inside the home.

For a forced-air system, the compressor “concentrates” (or “amplifies”) the heat, before it is distributed throughout the home by a blower motor feeding a conventional duct system. Another heat pump option uses a “water-to-water” heat exchanger to transfer the warmth from the fluid to an in-floor radiant heating system or baseboard units.

The greatest drawback to a geothermal heat pump is its high installation cost, which can be several thousand dollars more than the cost of a forced-air furnace/central air-conditioning system. However, depending on local electricity costs, the payback period can be just a few years—but certainly will be much shorter than the heat pump’s anticipated lifetime of 20 years or more. In addition, some utilities offer rebates on installation costs and special electric rates for geothermal heat pump users—and maintenance costs are low.

For the greatest efficiency, look for a geothermal heat pump with a two-stage compressor and a variable-speed blower.

What’s the scoop on the loops?

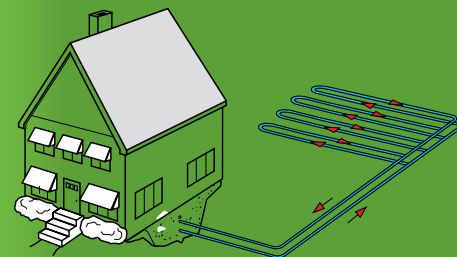

Horizontal loop

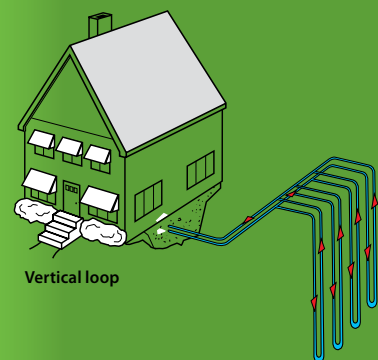

Vertical loop

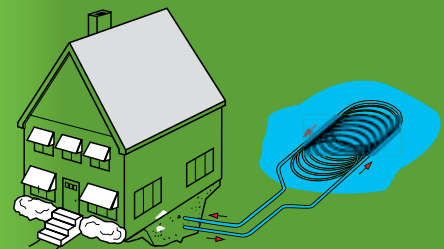

Pond loop

The most common types of loops for geothermal heat pump systems fall into three categories: a horizontal loop (*top*), a vertical loop (*center*) and a pond loop (*bottom*). Some loops are “closed,” meaning they circulate a fluid through a sealed loop underground; others are “open” and circulate well or ground water directly through the heat pump unit. In addition, many systems use coiled “slinky” pipes buried in the ground (similar to the ones shown in the pond illustration) instead of straight pipes, which concentrates the heat transfer surface into a smaller space; this is especially useful for installations in smaller yards.

Maintenance

CAUTION!

Always turn off the power to your heating system at the shutoff located next to the unit or the circuit-breaker panel (or fuse box) before performing any cleaning or maintenance tasks.

Regular tune-ups are important for maintaining the efficiency of any type of home heating system. You can handle a few simple tasks yourself if you're mechanically inclined, but you should call a professional technician for anything but the simplest service or repairs.

For example, a forced-air furnace or heat pump will run longer than necessary to warm your home if it has to fight to push air through a dirty air filter; regularly changing the furnace or heat-pump filter is a job you easily can manage. In addition, if you feel comfortable working on the system (with the power turned off), you can handle jobs such as vacuuming the blower, adjusting the blower belt, oiling the blower motor and flushing the condensation drain tube. However, for a gas furnace, make sure you call a professional to adjust the burner.

If you have a hydronic (boiler) system, you can bleed the radiators or check the water level in the sight glass on the boiler—but call a technician for other jobs.

Many heating and cooling companies offer discounted maintenance specials every fall, but make sure you know what's included in a checkup before hiring a company to do the work on your heating system. You may have to pay a little more than the special price to get a complete system evaluation and tune-up, but you'll likely recoup the higher service cost within a few months from lower utility bills.

Humidification

? Did you know?

You can buy a **hygrometer** to measure your home's humidity for as little as \$10-\$20; more expensive units are a little more accurate and allow you to check (and reset) their calibration. You also can watch for condensation on the windows; good-quality windows that are properly installed and weather-stripped should not show excessive condensation buildup at a 35 percent humidity level.

Humidity levels are lowest during cold-weather months, and the humidity in your home will be even lower if your home has an inefficient gas-forced-air furnace, all-electric heat or a system that uses outside air for combustion. When room air is very dry, moisture evaporates from your skin—just as if you were perspiring—making you feel chilly. Your natural inclination may be to raise the thermostat a couple of degrees, but a better, energy-saving solution *might* be to **add a humidifier** to your home's heating system.

To humidify or not to humidify, that is the question

The proper humidity level—many experts suggest around 35 percent—is a good thing for both you and your house during the winter. Besides allowing you to lower your thermostat setting two or three degrees because you'll feel warmer at higher humidity levels, a humidifier will minimize shocks from static electricity and reduce dry-skin and respiratory problems for your family. In addition, a little extra humidity will help prevent hardwood floors from shrinking, doors from sticking and furniture from drying out. On the other hand, too much humidity can create a breeding ground for mold, mildew and insects—and damage the drywall (or plaster), the insulation and the structure of your home.

Not all homes need additional humidity during the winter. For example, in a tightly constructed home built during the last several years, normal daily activities such as cooking, bathing, doing laundry and even breathing may provide adequate humidity levels. In fact, because of the low level of air infiltration in a newer home, some of these activities may add too much humidity, so be sure to use the kitchen exhaust fan when cooking and the bathroom fan during a shower. (Run the bathroom fan about 15 minutes after a shower to remove the humidity; running it longer will just pull heated air out of your home.) If you still note high humidity during cold-weather months, consider adding a heat recovery ventilator to your heating system. (See page 22 for more details on this option.)

Older, drafty homes need more help with humidity than newer homes. You may want to try a couple of *portable humidifiers* to place around your home, but a better choice (if you have forced-air heat) is to install a *whole-house humidifier* that attaches to the ductwork on your heating system. For a home with baseboard heat, radiant heat or radiators, look for a self-contained humidifier that hangs from the floor joists in the basement (or a heated crawl space) and connects to a floor vent mounted near the center of the home.

Passive Solar Energy

During daylight hours in winter, every time you let the sun shine into your home through south-facing windows, you're taking advantage of passive solar energy to help warm a room or two. On a larger scale, a well-designed passive solar home can cost about half as much to heat as a similarly sized home without solar features. But even if you're not planning to build a new home, there are some features you can add during a remodeling project to incorporate the energy-saving and environmental benefits of passive solar energy into your existing home.

A passive solar structure includes five elements

Taking advantage of passive solar techniques doesn't have to cost more than traditional construction. Consider, instead, that a passive solar structure includes a different arrangement of many of the same building materials you'd use in a conventional home.

- > The **aperture** is the large window area through which sunlight enters a home. The majority of windows should face within 30 degrees of true south and remain unshaded from 9 a.m. to 3 p.m. during the heating season.
- > The **absorber** is a dark surface—on a concrete floor, masonry wall or water container—that sits in the direct path of sunlight and collects the sun's heat.
- > The **thermal mass** is the material that stores the heat collected by the absorber. The absorber and thermal mass may be part of the same floor or wall; the absorber is the surface of the material, while the thermal mass is the storage medium under or behind it.
- > The **distribution method** is the way the solar heat circulates from the thermal mass to other areas of the house. Some designs rely on natural heat transfer—radiation, convection and conduction—while other designs use supplemental fans, blowers and/or duct systems.
- > The **control system** includes components that help manage temperatures. Some of these features may be structural, such as roof overhangs or blinds to shade the aperture during summer. Others are more high-tech, and could include electronic sensing devices that signal fans to start, as well as remote-control motorized dampers or vents that direct heat flow.

There are three types of passive solar designs

Whether you're building a new home or retrofitting the one you live in now, your passive solar project will fit into one of these three categories. Be sure to contact an architect who specializes in passive solar designs for your project, no matter what its scale.

- > A **direct-gain** design is the simplest passive solar system; the sun shines into the home and heats a thermal mass—typically a dark-colored masonry floor and/or wall—that holds and slowly releases the heat as the room cools at night. Some direct-gain designs use water-filled containers as the thermal mass, since water can store about twice as much heat as the same volume of masonry. However, a room filled with heavy water containers will need extra structural support, and the water must be treated regularly to prevent bacterial buildup.
- > An **indirect-gain** design uses a thermal mass that's placed between the windows and the living space in a home. The most common type of thermal mass is a *Trombe wall*, an eight- to 16-inch-thick, dark masonry wall with a layer of insulated glass mounted to it. (There's an air space between the glass and the wall.) Heat from the sun is absorbed by the wall and slowly conducts through the masonry into the home, when the indoor temperature falls below the temperature of the wall's surface.
- > An **isolated gain** design is a sunspace added onto a home, either as part of the home's original design or as a retrofit project. Some are designed as year-round rooms, while others can be closed off from the rest of the house when heating isn't needed and during warm-weather months. By the way, even though a greenhouse may seem to be a good design for solar heating a home, in reality it's not. The structure's overhead or sloped glazing is difficult to shade and can cause overheating of the space (especially during the summer), while the natural growth process of plants consumes heat energy through the evaporation of water.

Use simple physics to warm your home

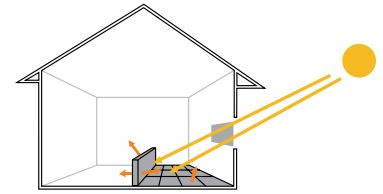

Heat naturally moves from warmer materials to cooler ones through radiation, convection and conduction. During cold weather, sunlight enters this home and strikes a thermal mass that collects and stores the sun's heat energy. At night—as the home cools—the heat is released from the thermal mass into the home. The next morning, the cycle starts again.

Here's how a passive solar sunspace works

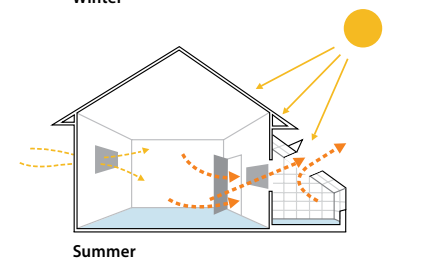
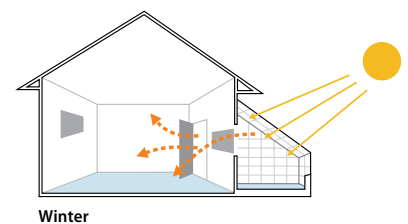

(Top) In this example, the low winter sun heats a sunspace and convection carries the heat from this area to adjoining rooms. (Bottom) During the summer, large roof overhangs and window shades inside keep the high sun from entering the house, while natural ventilation helps cool the home and prevents overheating in the sunspace.

Cooling

How an air conditioner works

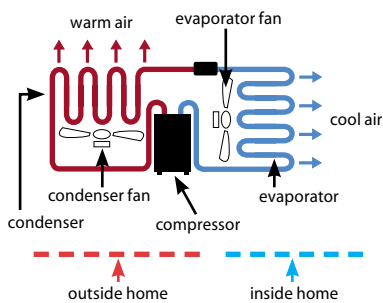

In a conventional central air-conditioning system, the evaporator is located inside the home, while the compressor sits outside.

? Did you know?

Let your air conditioner run while you're on vacation—especially during rainy or humid months. Set your thermostat to 85° F., so the system occasionally will run and dehumidify your home. This will help prevent mold and mildew.

Trees are year-round energy savers

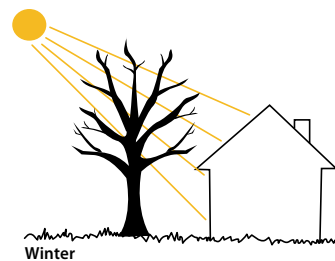
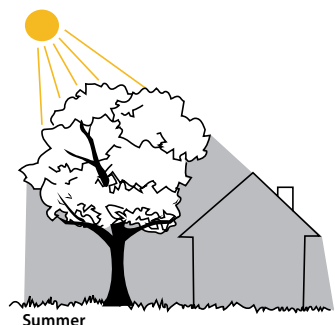

Deciduous trees not only provide shade during the summer but also allow the sun's warmth to reach the house throughout the winter.

Make the most of your air-conditioning system

Even though the first home air conditioner appeared during the late 1920s, home cooling didn't become a major consumer of energy until about 30 years ago. Today, it's hard to imagine not being able to escape to the comfort of an air-conditioned home on one of Iowa's hot and humid summer days.

Across the state, most residential cooling is handled by central air conditioners or room (window) air conditioners, although energy-efficient air-source heat pumps, add-on heat pumps and geothermal heat pumps are seeing greatly increased usage. However, no matter what type of system cools your home, there are many things you can do to cut the cost of running your air-conditioning unit while still staying comfortable.

Do you really know how an air conditioner works?

Many people think that a room air conditioner or a central air-conditioning system produces cool air, but technically that's not accurate. Instead, an air conditioner moves the heat from inside your home to the outdoors.

More specifically, a **compressor** pumps **refrigerant** from the **evaporator** inside your home to the **condenser** outside (The evaporator and condenser are made up of coils of copper tubing surrounded by aluminum fins.) As the warm indoor air passes through the evaporator coil, the liquid refrigerant inside evaporates; the resulting hot refrigerant gas is then pumped outdoors through the condenser, where it converts back to a liquid and releases the heat outdoors.

You can have a major impact on reducing cooling costs at home

There are four ways to keep your home cool and comfortable at an affordable cost.

- > Reduce the cooling load on your house.
- > Explore alternative cooling methods, such as natural ventilation and using fans.
- > Buy a new, energy-efficient air conditioner.
- > Increase the efficiency of your existing air conditioner.

In the sections that follow, you'll find many proven low-cost, low-tech methods for saving energy (and money) on your cooling needs, in addition to finding out what to consider when upgrading an existing air conditioner and maintaining your cooling equipment.

Reduce the cooling load on your house

The best strategy for keeping your home cool in the summer is to prevent it from getting hot in the first place. This means trying to keep the heat outside from being conducted inside—and reducing the amount of heat generated by things such as your appliances, television, computer, lights, water heater, bathing and cooking.

During Iowa's hot, humid summers, about half of the heat that accumulates in a home comes from solar gain; the other half comes from air leaks and heat-producing activities inside the home. In light of these figures, it makes sense to cut these loads before investing in a new air conditioner. Also, if you can reduce the heat entering your home, you should be able to get by with a smaller air-conditioning unit when you upgrade to new equipment.

Cut down on hot spots

Most of the heat gain inside a house comes from sunlight (or solar energy) hitting the roof and streaming through the windows. Energy conservation measures that block the sun before it strikes the roof or windows are the most effective ones to implement. Trees and other plants that provide shade are your best long-term investment for reducing cooling costs.

Solar heat gain is greatest in homes with dark roofs, inadequate insulation and poor attic ventilation. You can **reduce heat gain by a third by shading your house** with trees, adding insulation and ventilating the attic.

Air leaks that allow warm air into your home—and cooled air out—also are a costly problem if you have air-conditioning, especially in a humid climate such as Iowa’s. For more information on improving your home’s energy-saving “envelope,” ask your utility or the Iowa Energy Center for the book, *Home Series 1: Home Tightening, Insulation and Ventilation*. (See contact list on page 24.)

Survey your home to save

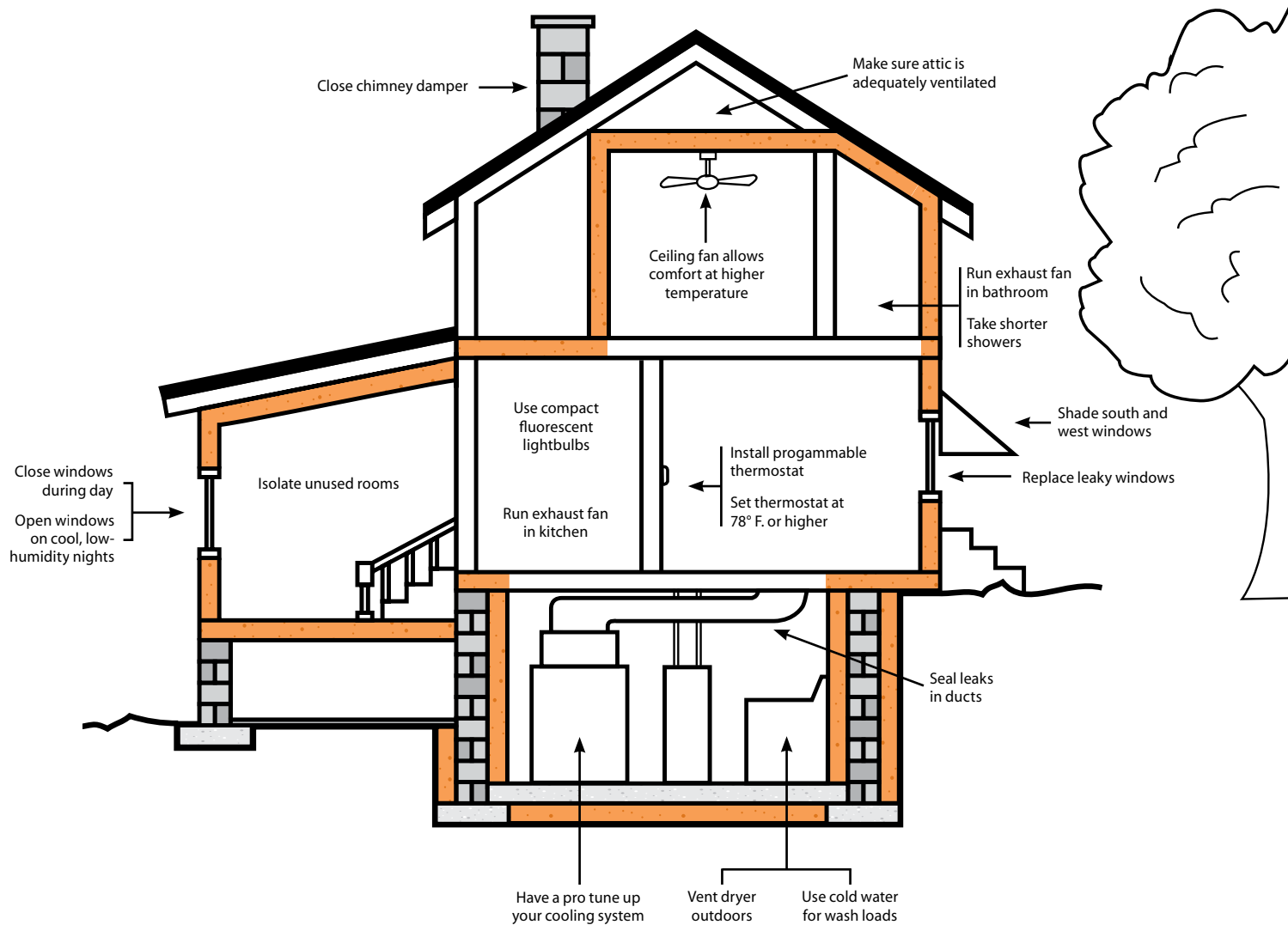

Common attic vent types

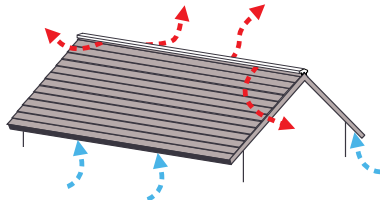

Soffit and continuous ridge vents

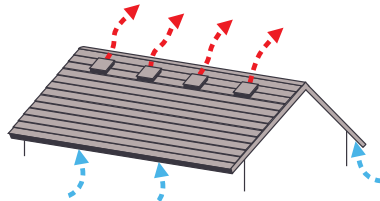

Soffit and box vents

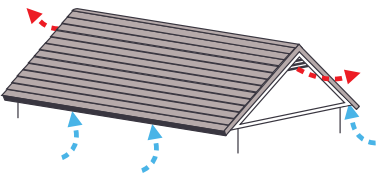

Soffit and gable-end vents

A combination of high and low roof vents in any of these configurations allows air to circulate naturally and prevent heat buildup in the attic.

Did you know?

Your utility may offer options that can save you money.

- **Special off-peak rates** may be available in late-evening or early-morning hours, offering you the opportunity to pay less for running high-consumption appliances during those periods.
- **Load-management programs** allow your utility to briefly cut power to your central air-conditioning system during peak load periods when the demand for power is high.
- **Budget billing charges** are the same every month so you won't get surprised by an unusually high power bill; your utility will adjust the amount regularly.

Follow these tips to keep your cool

Making a few minor changes in your daily habits—and tackling a few home-improvement projects around the house—can help you reduce your need for air-conditioning and add to energy savings during the dog days of summer. While all of the following suggestions may not be possible or practical for your situation, try incorporating several of them into your summer routine.

Natural Ventilation

Wind creates areas of positive and negative pressure around your house, so the windows near upwind areas will be **cool air inlets** and the windows near suction areas will be **warm air outlets**. Try a few tests to find out which windows to open to maximize natural ventilation.

Don't locate inlets and outlets directly opposite each other, because the only area that will be cooled will be in the direct path of the airflow. If the air has to take a longer path between an inlet and an outlet, more of your house will be cooled. Additionally, a slightly opened window will create a better air current than a fully opened one.

Close windows and doors during the hottest part of the day.

If your house is well-tightened and insulated, your inside rooms should stay relatively cool during mid- to late-afternoon hours.

Open windows on cool, low-humidity nights.

Natural or (fan-boosted) nighttime ventilation flushes out internal and solar heat that builds up during the day.

Use fans to boost a cross breeze.

Blow air from the cool side (the shady side) of your house to the hotter side.

Close windows early in the morning.

If you don't let warm air into your home, you can delay using your air conditioner until later in the day.

Leave windows closed when the humidity is high.

If it's humid and you use your air-conditioning regularly, you're better off not opening your windows on cooler days or at night. Your air conditioner will have to work extra hard to remove excessive humidity from your house before it can begin to cool it.

Make sure your attic is adequately ventilated.

Your roof can absorb a tremendous amount of heat during the summer. If it isn't properly insulated and ventilated, the temperature could reach 150° F., which is like having a gigantic radiator above your living spaces.

A home with a well-ventilated attic will have a solid comfort and energy-efficiency advantage over a home with a poorly ventilated attic.

Effective attic ventilation helps keep attic temperatures below 110° F. during hot weather, reducing the load on your air-conditioning system. If your attic gets too hot, the natural ventilation supplied by soffit vents and attic vents may not be adequate; you may need to add more vents. In addition, seal air leaks between the attic and the living spaces below—and add insulation, if necessary.

All around your house

The time you spend reducing or eliminating conditions that add heat (and humidity) to your home will be well spent; the smaller the difference between the temperature outside and the temperature inside, the lower your annual cooling bill. Take a tour of your home with the following lists in hand, to discover what you can do to save energy and cut utility costs.

Living areas

<p>Shade south and west windows to keep out the solar heat.</p>	<p>Stopping the sun’s warmth before it gets into your home with awnings or exterior solar screens is best. If that’s not possible, close inside blinds and curtains during the day; light colors will reflect the most heat. As an alternative, apply tinted plastic sun-control films or reflective coatings to the inside of your windows.</p>
<p>Keep the doors and windows closed during the day.</p>	<p>But on cool, low-humidity nights, open the windows and use natural ventilation (with or without fans) to cool your home.</p>
<p>Keep interior lights dimmed or turned off during daylight hours.</p>	<p>Turning on a table lamp for reading in a darkened room is a better choice than letting the sun stream in through a south or west window. On the other hand, north or east windows could provide enough light without significantly adding to the heat gain in an individual room.</p>
<p>Check your family’s lighting use.</p>	<p>Light fixtures generate heat and can add significantly to cooling costs. Turn off lights that really don’t need to be on.</p>
<p>In high-use areas, replace incandescent lightbulbs with compact fluorescent units.</p>	<p>Incandescent bulbs are very inefficient, using most of the energy they consume to create heat. A compact fluorescent lightbulb (CFL) produces the same light (and less heat) from 65%-75% less energy than a regular bulb—so a CFL can pay for itself during the life of the bulb.</p>
<p>Turn off or unplug the television and other electronic equipment when not in use.</p>	<p>Many video and audio components consume power and produce heat in the standby mode, so unplug them if you won’t be using them for several days. The only way to turn off the power supply for a device such as a cordless phone or cable TV box is to unplug it.</p>
<p>Minimize your computer’s power consumption when you’re not using it.</p>	<p>Shut down your computer if you’re not going to be using it for several hours. If you’re just going to be away for a few minutes, turn off the monitor—it still uses considerable power in the “screen-saver” mode—and put the hard drive in your CPU to sleep.</p>
<p>Construct a sunshade over a concrete patio.</p>	<p>A concrete slab will become a large heat sink during summer months, reflecting sunlight and radiating heat into your house. A shading structure will solve both problems, as well as making the outdoor space more usable on hot days.</p>
<p>If you’re building a room addition, keep cooling in mind.</p>	<p>Besides adequately insulating and weatherizing the new space, add 24-inch (or wider) overhangs to shade windows on the sunny sides of the new room. Also ask your contractor if your present cooling system can handle the additional load; if not, consider an energy-efficient supplemental system.</p>

Read the label

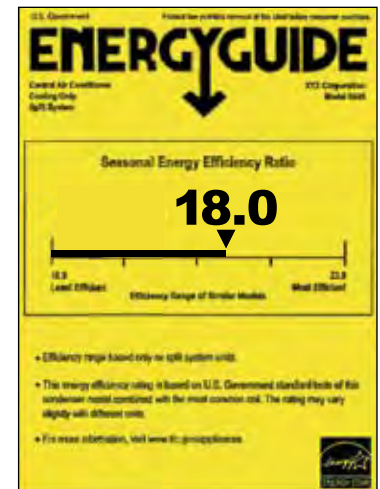

When shopping for an air conditioner, look for the EnergyGuide label that shows the energy efficiency of each model and allows you to compare the energy usage of competing systems.

Did you know?

You should reduce electricity use during summer **peak periods**, when energy demand at your local utility is highest. With so many people using electricity for air-conditioning at the same time, the price of power for this period may increase, because it costs the utility more to generate electricity when consumer demand soars. Although peak hours can vary due to weather conditions and demand, they generally fall from 3 p.m. to 9 p.m. on the hottest summer days.

Shade your compressor

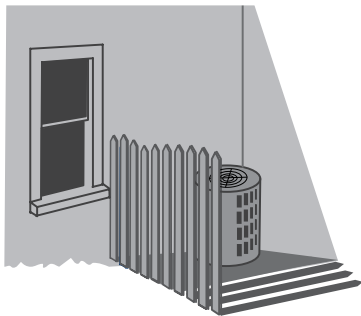

An air-conditioning compressor will run more efficiently if it's shaded by a fence, tree or landscaping during the hottest part of the day. Be sure to allow enough space around the unit for adequate air circulation.

? Did you know?

Many of the air leaks in a central air-conditioning system occur in the return air plenum, which is the large duct above or below the air handler. When these leaks occur, warm air is pulled into the system, making the air conditioner work harder. If your air conditioner is unable to satisfactorily cool your home, leaky ducts may be the cause.

Kitchen

Cover pots and pans on the cooktop or stove.

Cooking creates lots of heat and humidity, so contain it as much as possible.

Use an exhaust fan.

Vent steam and heat from cooking to the outdoors.

Run your dishwasher late at night.

Start the dishwasher when you go to bed. If it has a timer, set the dishwasher to run during nonpeak hours in the middle of the night.

Use the most energy-efficient appliances for cooking.

Instead of using your stove or oven, use your microwave oven or a countertop appliance such as a toaster oven, crock-pot, steamer or pressure cooker.

Replace old, inefficient appliances.

Even if an appliance still has a couple of years of serviceable life, replacing it with an efficient, ENERGY STAR® qualified unit is a good investment.

Use cold water for cooking.

Heating the water on your stove or cooktop consumes less energy than using hot water from your water heater—especially if doing so causes your water heater to cycle.

Check the temperatures in the refrigerator and freezer.

The temperatures should run 38°-40° F. in the refrigerator and 0°-5° F. in the freezer. Setting colder temperature levels wastes energy and makes these heat-producing appliances run too often.

Bathroom

Use an exhaust fan.

Reduce humidity by running an exhaust fan while you're in the shower. However, don't let it run too long, or it will pull cooled air out of your entire house.

Take shorter baths and showers.

Long baths and steamy showers add a lot of humidity to your home and can increase the time your air conditioner runs to overcome it. Install a water-saving showerhead too.

Laundry

Vent your dryer outdoors.

Check the lint trap, ducting and exterior vent frequently, to make sure they're clear. Excessive lint buildup can make your dryer run longer.

Dry clothes on an outdoor clothesline.

Wet clothes on an indoor clothesline will add humidity to your home and increase the load on your air-conditioning system.

Use cold water for wash loads.

Most clothes and other items will get clean in cold water, if you use the proper detergent. If you need to wash a warm- or hot-water load, run it during the late-evening or early-morning hours.

Only wash full loads.

If you don't have enough clothes for a full load, set the washer's water level to match the load's size.

Insulate the water heater tank.

The less often it cycles, the more energy you'll save.

Build a utility room to enclose the water heater and laundry.

Separating these heat producers from the rest of the house will reduce the load on your air-conditioning system. As a bonus, the rest of your home will be quieter too.

Fans

Fans are one of the oldest and most reliable mechanical means of cooling a home, and they use far less energy than air conditioners. In fact, you conceivably could run several fans and still consume a smaller amount of energy than you would by running a single room air conditioner.

However, fans don't cool rooms the same way air conditioners do; instead, **fans create a cooling effect by moving air across your skin.** So, opening the windows and using one or more fans during very hot and humid weather won't be an effective cooling strategy—especially if you're accustomed to using an air conditioner most of the time. Your cooling costs might go up by a significant amount, because opening the windows will increase the humidity your air-conditioning unit needs to remove, forcing the system to run longer than normal.

Window fans and whole-house fans are the best choices for accomplishing power ventilation in your home. Smaller floor, table and ceiling fans are best used to create a single-room “wind-chill” effect and are much less effective as whole-house ventilators. (During warm-weather months, make sure you run ceiling fans in a counterclockwise direction for maximum cooling.) No matter what type of fan you need, when you go shopping look for a fan that's ENERGY STAR qualified—and be sure to note its noise rating too. Also consider a fan with “airfoil-style” blades that are designed to maximize airflow.

? Did you know?

You should size a ceiling fan to the area of the room in which it's located.

Room Area (sq. ft.)	Fan Diameter (in.)
Up to 75	29-36
75-144	36-42
144-225	44
225-400	50-54

Source: ENERGY STAR and American Lighting Association

? Did you know?

Ceiling fans are available with a variety of mounts and downrod lengths for different slopes and heights of ceilings. Mount the fan as closely as possible to the middle of the room—at least seven feet above the floor; if the ceiling allows, a height of eight or nine feet is better for optimal airflow. A “hugger” fan, which mounts flush to the ceiling, will not move as much air because its blades will be just a few inches from the ceiling.

Use window fans to create cross-ventilation on warm, still days.	Open windows on the shady side of your house and position the fans so they blow air out of windows on the hot side of the house. The resulting pressure difference will cause air from the outside to flow through your house. While this option doesn't work well on very hot and humid days, you might be surprised at how well it works the rest of the time.
A ceiling fan will allow you to be comfortable at a higher temperature in occupied rooms and let you raise the thermostat in those areas.	A good ceiling fan should create enough air movement that you will be comfortable at 82° F. and 80% relative humidity. If you're using the fan to supplement or circulate air-conditioning, you should be able to raise the thermostat a full 4° F. above the standard 78° F. setting and still be comfortable. For every degree you raise your air conditioner's thermostat above 78° F., you'll save about 3%-5% on your cooling costs.
Choose the correct ceiling fan for damp or wet areas.	For a bathroom, buy a fan that has been U.L. listed with a <i>damp</i> rating. For a location where a fan might come into direct contact with water—such as a porch—select a fan with a <i>wet</i> rating.
On a cool, low-humidity night, a whole-house fan can cut the temperature in your home in a relatively short time.	A whole-house fan can reduce your home's indoor temperature by up to 20° F., depending on the temperature outside. This type of fan usually is installed in a hallway ceiling on the top floor of your house. It works by pulling the cool outside air from open windows on the lowest living level of the house into the attic, where warm air is vented to the outside.
A small fan is not adequate for cooling large areas.	An oscillating fan, box fan or table fan are good choices for one-person cooling, circulating the air in a small room or extending the cooling range of a window- or wall-mounted air conditioner.
Remove heat, humidity and odors from the kitchen and bathroom with a properly sized exhaust fan.	Don't leave an exhaust fan on longer—or at a higher speed—than necessary. In one hour, an exhaust fan can blow a house full of cooled air outside. Oven heat and shower humidity usually are removed within 15 minutes; a slightly opened window in the room can speed up this process.

Central air conditioner

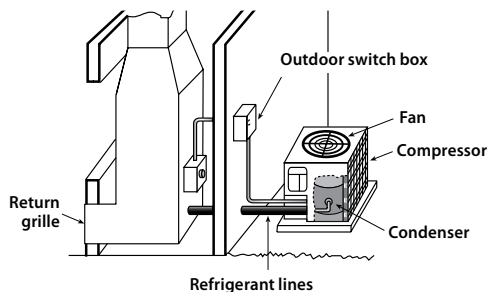

The most common residential central air conditioner is a split system where the evaporator is located inside, with the blower and other components of the furnace (or heat pump) connecting to ducts that run throughout the home. The outdoor unit includes the compressor and condenser; position it on the north or east side of your home, where it will be shielded from intense sunlight. Leave four to five feet of open air space around the unit to ensure enough air circulation for proper operation.

? Did you know?

One way to get around all of the construction necessary for adding ducts in a home built without them is to use a **mini-duct central air-conditioning system**. It uses a conventional air-conditioning compressor or heat pump outdoors and a special high-powered blower in the basement (the preferred location) or the attic. The system uses ducts with a two-inch inside diameter, so it's easy to run them through walls or the corners of closets to rooms above. You can buy heavily insulated ducts to run through an attic or other unfinished space, and ceiling, wall and floor outlets are available.

Central air-conditioning

A central air conditioner is more than just the largest appliance in a home—it's part of a carefully designed system that also incorporates a thermostat and an array of ducts that deliver and circulate cooled air throughout the structure. In most cases, a central air-conditioning system is a more energy-efficient choice for regularly cooling a home than using room air conditioners in three or four different rooms.

However, there's no getting around the fact that a central air conditioner can be fairly expensive to purchase—and that it must be installed by a qualified heating and cooling contractor. If your home doesn't have central air-conditioning—but does have a network of ducts for a forced-air furnace—you likely can use the same ducts for cooling, as long as they're the proper size and free of leaks and obstructions. On the other hand, if your home is heated by a boiler or electric baseboard units, you'll need to add a duct system, which can be both difficult and expensive—especially in a multi-level home, where you might have to sacrifice closet space or build “chases” along walls or in corners to hold the ducts.

You may want to upgrade if your system is 10 to 15 years old

If your home already has central air-conditioning, there are a couple of times to consider upgrading to a new system. First, start shopping if you will need to spend almost as much (or more) to repair your present unit as you would to replace it. Second, if your system is 10 years old or older, it's probably pretty inefficient, and you should consider replacing it with a newer one. (Some of the best models being sold today are **twice as efficient** as ones that were available 10 years ago.) Depending on the use, cost of electricity and temperature, the utility bill savings gained can pay back the cost of a new cooling system within a few years.

This may be the right time to upgrade your heating system too. Since both systems share components, it doesn't make sense to add a super-efficient air conditioner to an aging forced-air furnace—and you'll likely save money by updating both systems at the same time, as opposed to changing one now and the other in a couple of years.

When you go shopping, first consider the type of unit you need

If you're adding an air conditioner to an existing furnace—or just upgrading your existing central air-conditioning unit—you have two choices: a **conventional split system** (with the compressor unit outside and the evaporator inside) or an **add-on, air-source heat pump** that can cool your home in the summer and help with the heating load in the winter. If you're upgrading your entire heating and cooling system (or building a new home), you have other possibilities; in addition to a conventional split system, look at an **air-source heat pump** or a **geothermal heat pump**. (Heat pumps operate like conventional air conditioners, except they also run in reverse to provide heat during cold weather.) For more information on heat pumps, see page 7 in the Heating section of this book, contact your local utility or visit the Iowa Heat Pump Association Web site at <http://www.iaheatpump.org>.

No matter which type of cooling unit you choose, be sure to fully explore all of the **energy-saving options** available, including two-stage compressors that run in a special energy-saving mode on mild or less-humid days, new compressor designs with fewer moving parts than used in the past and environmentally friendly refrigerants.

Bigger isn't necessarily better

According to the U.S. Department of Energy, national surveys have indicated that more than half of all heating and cooling contractors don't properly size heating and cooling systems. For air-conditioning systems, **oversizing** is a real problem; not only do oversized units consume more energy, they also remove less moisture from your home and have a shorter service life.

The size of central air conditioners is measured in **Btu/hour** (British thermal units per hour). A reputable contractor will need to do a lot of investigating and calculating on a worksheet or computer to come up with the correct rating for your cooling system, considering things such as the size, style, orientation and shading of your home; insulation levels; window types, locations and sizes; air infiltration; location and condition of ducts; lighting and appliances in use; weather; your family's lifestyle; and your comfort preferences.

The **written bid** you receive should detail the sizing calculations in writing. Don't accept an estimate that is based only on the size of the existing unit, the square footage of your house or any other "rule of thumb."

What's SEER?

Buying an inefficient central air conditioner will guarantee high electric bills during the device's lifetime, so buy the most energy-efficient unit your budget allows. A central air conditioner's Seasonal Energy Efficiency Rating—**SEER**—measures the seasonal performance of the unit based on the cooling accomplished.

During the past few years, new technologies have helped the SEER ratings on the most efficient central air conditioners to rise above 20. The minimum SEER required by the Department of Energy for central air conditioners is 13, while the ENERGY STAR specification is 14. Both are a long way from a 1970's-vintage central air conditioner with a SEER of 6; by replacing that unit today with one that has a SEER of 20, you could cut your air-conditioning costs by about two-thirds.

Regular maintenance equals lower costs

A spring tune-up of your air-conditioning system will keep it working at top efficiency. Call a qualified heating and cooling specialist to handle these items.

- > Check the refrigerant charge and repair leaks. A system that is undercharged by 10 percent may drop 20 percent in efficiency. By the same token, an overcharged system can cause the refrigerant to flood and damage the air-conditioning unit.
- > Oil the bearings on the fan and compressor, if they're not sealed.
- > Test the compressor and blower controls.
- > Clean the condenser and fan.
- > Check all electrical connections for corrosion.
- > Clean the evaporator and blower, and flush the drain line.
- > Readjust the duct dampers.
- > Check the temperature rise of the outside unit while it's running, and check the temperature drop through the indoor coil.
- > Test overall operation of the unit (including thermostat).

You may be able to handle the following maintenance items. Read the instructions that came with your system, and be sure to turn off power to the unit before you start.

- > Check filters monthly and clean or replace them as needed.
- > Once a year, clean the evaporator coil with a biodegradable cleaner and a soft brush if it's easily accessible; if not, leave the job for a trained technician.
- > Clean the condensate pan, too, and make sure the drain hose isn't plugged.
- > When dirt has built up, clean the condenser coils. Use a biodegradable cleaner and a soft brush to gently clean the coils and flush them with clean water. Clean the blower's fan blades too. Don't just blast the parts with a hose!
- > Straighten the fins in evaporator and condenser coils with a "fin comb" from an air-conditioning parts supplier.
- > Remove debris around condensing unit and trim bushes and grass to maintain airflow.



Did you know?

A central air-conditioning system or heat pump can heat water with the addition of a **desuperheater**—a heat recovery unit that captures waste heat from a central air conditioner, heat pump or geothermal heat pump and uses it to heat the water in a water heater. Since the desuperheater only works when the system's compressor is running—and the equipment is relatively expensive—the payback period for a home in Iowa's climate will be pretty slow. Ask a heating and cooling contractor for a detailed analysis on whether a desuperheater makes sense for your home.

CAUTION!

Always turn off the power to your central air-conditioning unit at the shutoff located next to the compressor outside your home or the circuit-breaker panel (or fuse box) before performing any cleaning or maintenance tasks.

Room (window) air conditioner

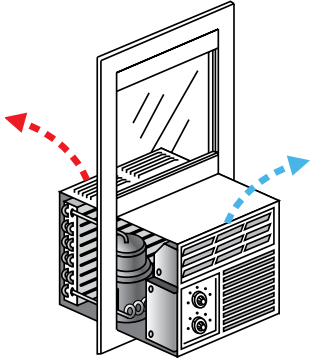

A room air conditioner functions in the same way as a central air-conditioning system, but on a much smaller scale.

CAUTION!

Don't remove the third prong on the plug for a room air conditioner to make the plug fit into an older two-slot wall outlet. The third prong is a safety device that protects you from a shock in the event of a malfunction in the unit. Instead, call an electrician to install a properly grounded outlet for the exclusive use of the air conditioner. In addition, never use an extension cord with an air conditioner; plug the unit's cord directly into the closest outlet.

Made in the shade



For peak operating efficiency, locate room air conditioners on the north side of your home or in a shaded area—and, if possible, in the middle of each room for better air distribution.

Room air conditioners

Room air conditioners—sometimes called window units—mount in a hole cut into an exterior wall or in a window frame. (Portable units that roll from room to room and vent through a window also are available.) Room air-conditioning units are designed to cool one room at a time, and you would need multiple units to cool an entire house. However, room air conditioners are a good choice if you only need to cool one or two rooms, live in an apartment or own a very small, well-insulated home. One or more energy-efficient room units can be less costly to run than an older, full-sized central air-conditioning system; on the other hand, a couple of older room units can be more expensive to operate than a new central unit.

Energy-efficient room air conditioners are moderately inexpensive and fairly easy to install in a wall using basic carpentry skills—although some models weigh around 100 pounds, so installation could be a two-person job. The opening around the unit, whether it's mounted in a wall or window, must be sealed to prevent air leaks. And if you don't remove the unit every fall for winter storage, cover it with a fitted, insulated blanket made specifically for that purpose to keep cold air from infiltrating your home.

When shopping for a new unit, consider size and efficiency

A room air conditioner that's sized correctly will handle both the heat and humidity in a room. Some people buy an oversized unit, assuming that it will do a better job of cooling. But remember that an air conditioner must remove heat and humidity from the air, and it's designed to do both during a normal cycle. A unit that's too large may cool a room quickly, but the resulting short cycle won't allow it to reduce the humidity to an acceptable level.

The cooling capacity (size) of a room air conditioner is measured in **Btu/hour** (British thermal units per hour) and is dependent on the square footage of the room you want to cool. After figuring the square footage of the room, use the chart (right) to determine what size air conditioner best fits your needs. If the room is on the sunny side of your house, increase the air conditioner's capacity by 10 percent; if the room is shaded, subtract 10 percent. For a kitchen-mounted unit, boost the capacity by 4,000 Btu/hour. And if more than two people usually occupy the room, add 600 Btu/hour for every additional person.

At the store, check the yellow EnergyGuide label on each air conditioner for its **EER**—Energy Efficiency Ratio—the unit's cooling output (Btu/hour) divided by its power consumption. Average units have an EER around 10, but buy a unit with an EER of 11 or higher for maximum efficiency; you'll more than make up the higher cost of the more efficient unit through future energy savings.

Room Area (sq. ft.)	Capacity (Btu/hour)
100-150	5,000
150-250	6,000
250-350	7,000
350-400	9,000
400-450	10,000
450-550	12,000
550-700	14,000
700-1,000	18,000

Source: ENERGY STAR

What about maintenance?

After unplugging the air conditioner, check its owner's manual for tips on cleaning or replacing the inside air filter. (Usually you have to remove an access panel to reach it.) Then gently clean the aluminum fins on the evaporator coils behind the filter with a soft brush, working in the same direction the fins run. Finally, use a biodegradable disinfectant solution to flush the drain pan in the bottom of the unit that collects condensation from the evaporator coils and directs it outside. This is a good time to make sure the pan is draining completely too.

You also can remove the outside cover of the air conditioner and use a soft brush and disinfectant solution to carefully clean the condenser coils and aluminum fins. If the dirt doesn't come off easily, don't scrub too hard or you may damage the fins.

Call a professional service technician for all other maintenance work.

Landscaping for comfort

Besides making your homestead a greener and more beautiful place to live, trees and landscaping are the most effective long-term measures for reducing your home's energy consumption for heating and cooling. For example, **deciduous trees**—which are bare in the winter and leafy during the summer—allow winter sunshine to come through their branches when it's cold and warm your home, and screen out the summer sun when the branches are filled with leaves. Choose deciduous trees that don't have a heavy branch structure (which could block the sun), and plant them on the east, south and west sides of your home for the maximum shading effect. On the north and west sides of your home, use **evergreens** as a windbreak to reduce the chilling effect of winter winds. And add **low bushes or hedges** to direct summer breezes toward your home.

Mature trees and shrubs “protecting” your home can have a dramatic effect on utility bills, according to the U.S. Department of Energy Office of Energy Efficiency and Renewable Energy. For example, an energy-saving landscaping design can **cut heating bills by about one-third** during cold-weather months. The potential savings during warm-weather months are equally dramatic: A well-planned landscape can **reduce an unshaded home's summer air-conditioning costs by 15 to 50 percent**, depending on how tight the structure is and how well it's insulated.

Keep these things in mind as you plan your energy-saving landscape design:

- Talk with local tree and landscaping experts or state extension staff for help in choosing the right trees for your home size and soil type.
- Plant trees so there will be enough space between the trees at maturity and the house (for both branches and root systems). Consider the proximity to neighbors' homes too.
- A windbreak can reduce wind speed for as far as 30 times the height of the windbreak. However, for maximum effect, plant your windbreak a distance from your home that's two to five times the mature height of the trees you're using.
- For the most effective type of winter windbreak that slows both wind and snow drifting, plant shrubs, build a fence or create an earth berm on the windward side—near the bases—of tall evergreens.
- Ultimately, trees should shade your roof, as well as the sides of your home during late spring, summer and early fall. Dark-colored home exteriors absorb up to 90 percent of the sun's radiant energy; some of this heat gain is conducted to the interior of your home, no matter how well it's insulated.
- The more shade you have, the more effectively you can use natural ventilation. Shade makes the air around the house cooler, and it prevents solar heat from being conducted indoors.
- Temperatures directly under trees can be up to 25° F. cooler than air temperatures around nearby blacktop, due to shading and evaporative cooling.
- Use light-colored mulch or ground cover to reflect heat away from your house.
- Trees are a good investment. Studies by real estate agents and professional foresters estimate that trees raise a home's resale value seven to 20 percent. In addition, your home's roof and siding materials will last longer due to reduced exposure to the sun's ultraviolet rays.



A carefully developed landscape can reduce your annual heating and cooling bills by a substantial amount.

Did you know?

The National Arbor Day Foundation's Web site at <http://www.arborday.org> is a good resource for information on choosing the right trees for your energy-saving landscape. You can search by tree category, soil type, sun exposure and hardiness zone — most of Iowa is in Zone 5—and even order trees.

Create an energy-saving landscape

Windows

A window is a complex system

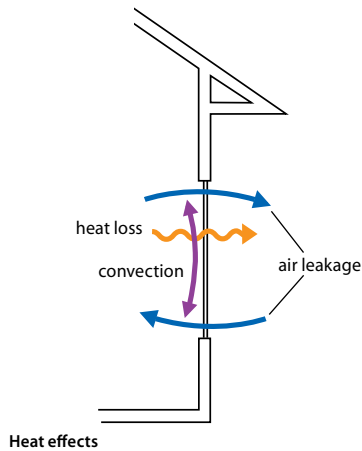

Heat effects

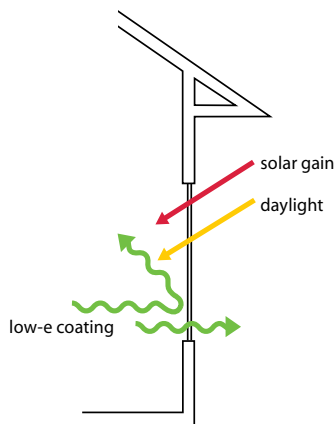

Radiation effects

Besides style and frame materials, there are many other factors to evaluate when buying windows for your home. (Top) Heat effects include *U-factor* (heat loss), *convection* (glazing and low-conductivity gas between panes) and *air leakage* (infiltration). (Bottom) Radiation effects consist of *solar heat gain coefficient* (amount of sun's radiation transmitted through window), *visible transmittance* (level of daylight coming through window) and *emissivity* (low-e coating on glass to reflect heat back into the heated space and reduce heat loss). Some manufacturers also include a rating for *condensation*, on a scale from 1 to 100; the higher the number, the better a window resists condensation.

You may not think of your windows as being an integral part of your home's heating system, but consider this: According to the U.S. Department of Energy, **windows account for 10 to 25 percent of your heating bill**. As a result, it's important to make the most of their virtues—light, view, solar gain and comfort—and reduce their vices—heat loss at night, air leaks and that chilly feeling when you're standing nearby.

Open window coverings on south-facing windows to take advantage of solar heat gain.	Letting the sun shine into your home—even through just a couple of south-facing windows—can provide enough heat to reduce the load on your heating system. As soon as the sun stops shining into your home, cover the windows to minimize heat loss.
Cover east-, north- and west-facing windows whenever possible.	Heavy curtains or insulated shades are best for reducing chills when it's dark. Also keep windows covered during the day—unless you need the natural light—since there will be little solar heat gain.
Keep the doors and windows closed as much as possible.	Besides diluting the heated air in your home, a wintry blast reaching your thermostat can fool it into thinking the whole house is too cool and signal your heating system to start unnecessarily.
Repair and install storm windows.	Storm windows can reduce heat loss by 25%-50%. Make sure the glass isn't cracked and that the gaskets are in good shape.
Wash south-facing windows.	Dirt and grime on windows can reflect part of the solar heat gain you'd otherwise get from these windows.
Trim trees and bushes in front of windows.	Deciduous trees and shrubs will drop their leaves to let in sunshine. Cut back other types that block the low winter sun.

Of course, **solar heat gain through windows during the summer will increase your home's air-conditioning load** and raise cooling costs. See pages 13 and 19 for tips on reducing the effects of the sun's warmth on your house during the warm-weather months.

Replace leaky old windows with energy-saving units

If you're remodeling or building a new home, buy the most energy-efficient windows you can afford; your being able to use a smaller-capacity heating and cooling system should offset their higher initial installation cost. Shop for windows that include **double or triple glazing**, a **low-conductivity gas such as argon between the panes** and a **low-e (emissivity) coating** on the glass. Also look for high-quality wood, clad or insulated vinyl window frames.

The National Fenestration Rating Council rates windows in these performance categories, although not all window manufacturers display them on the window packaging.

- > **U-factor** is the rate of heat loss through a window. Lower is better, so look for double- or triple-glazed windows with a U-value of 0.35 or below.
- > **Solar heat gain coefficient** (SHGC) is the amount of solar radiation transmitted through a window. To maximize the benefit of warmth from the sun, choose the highest SHGC possible (about 0.30-0.60) for the appropriate U-factor.
- > **Visible transmittance** indicates the amount of visible light transmitted through a window. To maximize daylight, look for windows with the highest visible transmittance rating.
- > **Air leakage** measures the heat loss (and gain) that occurs by air infiltration through a window. The lower the number, the less air will go through a window assembly; look for a rating of .30 or less.

Check the Web sites of the National Fenestration Rating Council (<http://www.nfrc.org/>) and the Efficient Windows Collaborative (<http://www.efficientwindows.org/>) for details.

Thermostats

A thermostat is a simple device—it's just a temperature-controlled on/off switch for your heating and cooling system. However, a thermostat can have a major impact on your annual heating and cooling costs; during cold weather set it as low as possible, and during warm weather set it as high as possible—without sacrificing comfort. According to the U.S. Department of Energy, setting back your thermostat by 10 to 15 percent for eight hours a day can **reduce your annual heating and cooling bill by as much as ten percent.**

This energy saver can pay for itself in less than a year

A **programmable thermostat**—a thermostat combined with a clock—can handle daily system temperature changes for you automatically, all year long. Once you set a programmable thermostat, you can forget it—unless you want to change the program. In fact, some programmable thermostats come preprogrammed from the factory, so you can use the standard program or easily modify it to meet your family's needs.

For example, during warm-weather months, the thermostat program will cycle the cooling system so your home is a comfortable 78° when you get up in the morning—and then allow the temperature to go to 85° during the day while you're at work. Later, when you arrive home from work, the system will have cooled your home back to 78° again. After you go to bed, the thermostat can raise the temperature a few degrees to save even more energy before repeating the cycle the next day.

Look for these features

The least-expensive (under \$40) ENERGY STAR® qualified programmable thermostats are pretty basic and offer a single program with four settings—*wake*, *leave (day)*, *return (night)* and *sleep*—for weekdays and a second program with four settings for the weekend. Some also include a few other features such as battery backup for the program, a monitor that indicates when to change the furnace filter and a temporary program override to use, for example, if you stay home from work.

However, if your budget allows, spend \$50-\$100 (or more) for a **smart programmable thermostat**. A “7-day” smart thermostat, for instance, will let you set a separate program for each day of the week. Some upscale thermostats offer six programs per day, automatic switching between heating and cooling modes and one-button *hold temperature* and *vacation* settings. In addition, several thermostats include a separate program for the blower fan, as well as offering control of a whole-house humidifier (for winter), a variable-speed fan blower (for humidity control during summer) or a fresh-air ventilator (year-round). You even can remove most programmable thermostats from the wall to program them—and a couple come with remote controls, so you can change thermostat settings from anywhere in your home.

Finally, look for a thermostat with an *advanced recovery* or *ramping* feature that helps your heating and cooling system deliver the correct temperature at the right time, in the most economical way possible. This feature monitors indoor and outdoor temperatures and humidity and gradually brings your home to the requested temperature (usually over a period of hours), so the system doesn't have to deal with a large temperature shift all at once.

Mount your thermostat away from windows or doors; sunlight streaming through a window or a chilly breeze from an open door can trick your thermostat into thinking your heating or cooling system should cycle. Many thermostats—from the simplest, most inexpensive ones to the fanciest, programmable units—are designed for do-it-yourself installation. Just turn off the power to your heating and cooling system, remove the old thermostat and attach the existing system wires to the correct terminals on the new thermostat. However, if the wires aren't color-coded or the new thermostat requires additional wires, call a professional installer for help.

Typical programmable thermostat settings for winter

	Wake 70°	Leave 60°	Return 70°	Sleep 62°
Mon	6:00a	7:30a	5:30p	10:00p
Tue	6:00a	7:30a	5:30p	10:00p
Wed	6:00a	7:30a	5:30p	10:00p
Thu	6:00a	7:30a	5:30p	10:00p
Fri	6:00a	7:30a	5:30p	11:00p
Sat	8:00a	9:00a	6:00p	11:00p
Sun	8:00a	9:30a	1:30p	10:00p

In this example showing heating settings, the system will warm the house to 70° by the time the family wakes up during weekdays, but wait until 8:00 a.m. on weekends because the family sleeps later. After everyone leaves for work or school Monday through Friday, the thermostat will let the house cool to 60°—and raise the temperature back to 70° again for everyone's arrival around 5:30 p.m. On Saturday and Sunday, the program varies according to the family's schedule.



Did you know?

When you install a programmable thermostat, be sure to recycle the unit you're replacing. Many older wall thermostats equipped with a dial or lever contain a glass-bulb mercury switch to provide efficient temperature control.

Mercury can be harmful to the environment and human health. The likelihood of being exposed to the mercury in the switch is very low, but you should handle the thermostat carefully after removing it and dispose of it properly.

The not-for-profit Thermostat Recycling Corporation facilitates the collection of used mercury-switch thermostats. To find out if distributors or contractors in your area participate in this program, go to <http://www.nema.org/gov/ehs/trc>.

Heat recovery ventilators

Out with the bad air, in with the good

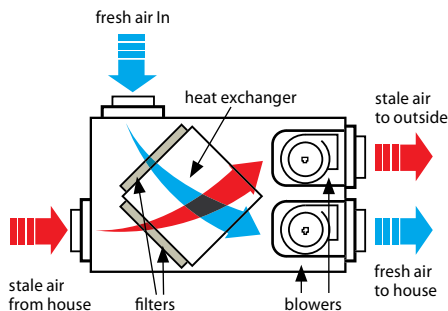

Although there are several different styles of HRV, they're all designed to do the same thing: exhaust stale air from—and bring fresh air into—a home. When shopping for an HRV, be sure to consider the controls that come with each unit. Certain HRVs include automatic controls with humidity sensors, while others include only manual fan speed and/or timer switches. Some HRVs also include a defrost cycle or vent to prevent buildup of ice during very cold weather.

One of the problems with new homes that are constructed very tightly—or existing ones that are remodeled to significantly reduce air leaks—is that the air inside can get pretty stale. Besides stuffy air, **some of the signs of inadequate ventilation** in a home include mold and mildew growth on walls, excessive condensation on windows and other cold surfaces (during the heating season) and high humidity (any time of year); for your family, the symptoms include headaches, dizziness, fatigue and respiratory problems.

There are many sources of indoor pollution, including things such as fuel-burning heating systems and appliances, gasses released by adhesives used in building materials, vapors from home-cleaning products and radon. Eliminating these pollution sources from your home is only part of the answer; you also need to bring fresh outdoor air into your home.

Of course, you can open a couple of windows to help reduce the pollution, but obviously that defeats the energy-saving purpose of creating a tight home in the first place. A better idea is to install an air-to-air **heat recovery ventilator (HRV)** to remove pollutants and bring fresh air into your home, without wasting your energy dollars. An HRV is designed to exchange contaminated air from your home with fresh air from outside—without wasting the energy dollars you've spent to heat or cool your home.

During the winter, stale, heated air from your home runs through a heat exchanger in the HRV that captures up to 80 percent of the air's heat energy, before exhausting the contaminated air outdoors. At the same time, fresh outdoor air passing through the heat exchanger is warmed before it's released inside the home, either through existing heating system ducts or a separate system of ducts connected only to the heat exchanger. *During the summer*, stale, cooled air runs through the heat exchanger, cooling the fresh, hot outdoor air before it reaches the distribution ducts.

A similar system, called an **energy recovery ventilator (ERV)**, adds an important function to the ventilation process: It also transfers humidity. During cold months, the ERV sends humidity from the exhaust air to the incoming fresh air, helping to raise the home's humidity to a comfortable level—unless there's already enough humidity in the home, at which point the ERV vents the excess humidity outdoors. During warm months, the ERV can exhaust humid air outside, assisting the central air-conditioning unit.

Note that the need for humidity control is different in every house on every day of the year. Ask your heating and cooling contractor for recommendations on using an HRV or ERV.

Ducts

Turbocharge your ducts

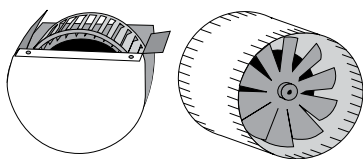

If a room at the end of a long duct run always seems to be cooler than other rooms—and you've already fixed duct leaks, insulated the ducts and rebalanced the whole duct system—an electric **booster fan** that mounts to the problem duct may help.

According to ENERGY STAR®, **leaky ducts** can reduce a home heating and cooling system's efficiency by up to 20 percent. That can add up to hundreds of dollars per year on your energy bills!

As a result, it's very important to hire a **professional to pressure test and inspect the network of ducts** in your home to ensure that all the heated or cooled air is reaching the appropriate rooms. The technician should look for loose joints, holes or leaks and fix those problems using metal-backed tape (not cloth-backed duct tape), mastic or an aerosol-based sealing material. In addition, **insulate the ducts with** a material rated R-6 or higher—especially if they run through an unheated basement or crawl space. Remember that doing so will make those areas colder, so insulate the walls in the basement or crawl space too.

Another common problem with ducted systems is **uneven temperatures** in rooms throughout a home. This situation may be caused by leaks, but it also may be due to the duct system's original design. If each branch of the duct network doesn't include simple metal dampers in the ducts, have them installed; then you'll be able to adjust the amount of conditioned air that goes to each room and balance the temperatures throughout your home. If installing dampers is not a practical solution—for example, if the supply ducts are hidden above a finished basement ceiling—add adjustable registers in each room.

Hiring a contractor

- 1 **Be prepared.** Find out about license and insurance requirements for contractors in your area. Before you call a contractor, know the model of your current heating and cooling system, as well as its maintenance history.
- 2 **Consider a certified professional.** Look for a contractor who employs technicians certified by NATE (North American Technician Excellence), the leading industry-supported testing and certification program.
- 3 **Call references.** Ask each contractor for customer references, and call them. Ask about the contractor's installation or service performance—and if the job was completed on time and within budget.
- 4 **Find special offers.** A heating and cooling system is one of the largest purchases you'll make as a homeowner. Keep your costs down by checking around for available rebates on energy-efficient, ENERGY STAR® qualified heating and cooling equipment. Begin your search at www.energystar.gov, and ask the contractors and your utility company too.
- 5 **Look for ENERGY STAR qualified products.** They meet strict energy-efficiency guidelines set by the U.S. Environmental Protection Agency and offer significant long-term energy savings. Contractors should be able to show you calculations of savings for ENERGY STAR heating and cooling equipment.
- 6 **Expect a home evaluation.** The contractor should spend significant time inspecting your current system and home to assess your needs. A bigger system isn't always better; a contractor should size the heating and cooling system based on criteria such as the square footage of your house, level of insulation and total window area. A good contractor also will inspect your duct system (if applicable) for air leaks and insulation, as well as measure airflow to make sure it meets manufacturers' specifications.
- 7 **Get written, itemized estimates.** When comparing bids, be sure to consider warranties and equipment disposal.
- 8 **Get it in ink.** Sign a written proposal with a contractor before work gets started. The document should specify project cost, model numbers, schedule and warranty.
- 9 **Pass it on.** Tell friends and family about ENERGY STAR and a good contractor.
- 10 **Get the ENERGY STAR Guide.** For information on keeping your home comfortable year-round, download the *ENERGY STAR Guide to Energy Efficient Cooling and Heating* at <http://www.energystar.gov> or call 888-782-7937 to order a copy.



Did you know?

Energy specialists offer many different services, so make sure you ask the right questions and provide enough information to find one that specializes in the type of work you need.

- A **home energy rater**, for example, is a specialized contractor who performs a standardized evaluation of the energy efficiency of a home. The evaluation should include an on-site inspection, air leakage test of your home and ductwork, computer analysis of estimated savings and home energy rating.
- An **energy auditor**, on the other hand, completes an evaluation of the efficiency of a home that may or may not be as comprehensive as a home energy rating.
- A **heating and cooling contractor** sells, services and installs furnaces, boilers, central air conditioners, heat pumps, ducts and programmable thermostats. Some heating and cooling contractors also provide specialized services such as airflow balancing, duct sealing and energy or comfort audits.

Source: ENERGY STAR

Disposing of old equipment

In the past, old furnaces and air conditioners often were dumped in landfills or even ditches. Very few of these units were recycled, and the **hazardous materials** in them—refrigerant, PCBs and mercury—contaminated the soil and ground water. Today, the state requires that a **demanufacturer** remove the hazardous components from discarded appliances, before disposing of them in an environmentally sound manner and recycling the remaining metals.

There are many locations across the state that gather discarded furnaces, air conditioners and appliances for processing by a demanufacturer. To locate a collection site near you, contact your local solid waste agency or go to the Waste Management Web site of the Iowa Department of Natural Resources at <http://www.iowadnr.com/waste/>.

Alliance to Save Energy

1850 M Street, NW, Suite 600
Washington, DC 20036
Phone: 202-857-0666
Web site: <http://www.ase.org/>

Alliant Energy

4902 North Biltmore Lane
P.O. Box 77007
Madison, WI 53707-1007
Phone: 800-255-4268
Web site: <http://www.alliantenergy.com/>

**American Council for an
Energy-Efficient Economy**

1001 Connecticut Avenue, NW, Suite 801
Washington, DC 20036
Phone: 202-429-8873
Fax: 202-429-2248
Web site: <http://www.aceee.org/>

Aquila, Inc.

1701 48th Street, Suite 260
West Des Moines, IA 50266
Phone: 816-421-6600
Web site: <http://www.aquila.com/>

Atmos Energy Corporation

24 South 10th Street
Keokuk, IA 52632
Phone: 888-286-6700
Web site: <http://www.atmosenergy.com/>

Energy Efficient Rehab Advisor

Web site: <http://rehabadvisor.pathnet.org/>

ENERGY STAR®

1200 Pennsylvania Avenue, NW
Washington, DC 20460
Phone: 888-782-7937
Web site: <http://www.energystar.gov/>

Federal Trade Commission (FTC)

Consumer Response Center
600 Pennsylvania Avenue, NW
Washington, DC 20580
Phone: 877-382-4357
Web site: <http://www.ftc.gov/appliances/>

**Gas Appliance Manufacturers
Association (GAMA)**

2107 Wilson Boulevard, Suite 600
Arlington, VA 22201
Phone: 703-525-7060
Web site: <http://www.gamanet.org/>

Home Energy Saver

Environmental Energy Technologies Division
at the Lawrence Berkeley National Laboratory
Web site: <http://hes.lbl.gov/>

IowaENERGY.org

Web site: <http://www.iowaenergy.org/>

Iowa Association of Electric Cooperatives

8525 Douglas, Suite 48
Des Moines, IA 50322-2992
Phone: 515-276-5350
Fax: 515-276-7946
Web site: <http://www.iowarec.org/>

**Iowa Department of Human Rights/
Division of Community Action Agencies**

Lucas State Office Building
321 E. 12th Street
Des Moines, IA 50319
Phone: 515-281-3861
Fax: 515-242-6119
Web site: <http://www.state.ia.us/government/dhr/caa/>

Iowa Association of Municipal Utilities

1735 NE 70th Avenue
Ankeny, IA 50021-9353
Phone: 515-289-1999
Fax: 515-289-2499
Web site: <http://www.iamu.org/>

Iowa Department of Natural Resources

502 E. 9th Street
Des Moines, IA 50319-0034
Phone: 515-281-5918
Web site: <http://www.iowadnr.gov/>

Iowa Office of Energy Independence

Lucas State Office Building
312 E. 12th Street
Des Moines, IA 50319
Phone: 515-281-0187
Web site: <http://www.energy.iowa.gov/>

Iowa Renewable Energy Association

P.O. Box 3405
Iowa City, IA 52244-3405
Phone: 319-643-3160
Web site: <http://www.irenew.org/>

Iowa State University Extension

Answer Line Phone: 800-262-3804
Web site: <http://www.extension.iastate.edu/answerline/>
or <http://www.extension.iastate.edu/housing/>

MidAmerican Energy

666 Grand Avenue, Suite 500
Des Moines, IA 50309-2580
Phone: 888-427-5632
Web site: <http://www.midamericanenergy.com/>

**U.S. Department of Energy Office of
Energy Efficiency and Renewable Energy**

Forrestal Building
U.S. Department of Energy
1000 Independence Avenue, SW
Washington, DC 20585
Phone: 877-337-3463
Web site: <http://www.eere.energy.gov/>

U.S. Environmental Protection Agency

Ariel Rios Building
1200 Pennsylvania Avenue, NW
Washington, DC 20460
Phone: 202-272-0167
Web site: <http://www.epa.gov/>



This is an Iowa Energy Center publication.

The Iowa Energy Center is a research, demonstration and education organization dedicated to improving Iowa's energy efficiency and use of renewable energy. The Energy Center meets its goals by developing in-house energy research and education programs and by sponsoring energy projects developed by other groups. The projects supported by the Energy Center, which vary in size and complexity, are conducted throughout the state in Iowa's universities, colleges, community colleges and private nonprofit organizations.

Iowa Energy Center

2521 University Boulevard, Suite 124, Ames, IA 50010-8229
Phone: 515-294-8819 | Fax: 515-294-9912 | E-mail: iec@energy.iastate.edu
Web site: <http://www.energy.iastate.edu>



Water Heating

3



- 🏠 Use less hot water to save money on utility bills
- 🏠 Increase your water heater's efficiency—page 6
- 🏠 Regular maintenance makes a difference—page 8
- 🏠 Evaluate water heater features when shopping—page 9

Reduce use and increase efficiency



Did you know?

A tax credit can provide significant savings after you buy a qualified energy-saving water heater. Consult your tax adviser or go to the Tax Incentives Assistance Project at <http://www.energytaxincentives.org> or the Alliance to Save Energy at <http://www.ase.org/>.

Although there are many ways to cut your water heating bills, they all fall into two broad categories: reducing the amount of hot water you use and making your water heating system more efficient. Fortunately, there are several strategies that can help you consume less energy and save money—and still meet your hot water needs without sacrificing comfort or practicality.

This booklet was designed to answer common questions about hot water systems and to provide you with the information necessary to make informed decisions about a wide variety of topics, ranging from repairing hot water faucet leaks and insulating water supply pipes to installing low-flow showerheads and tuning up your existing water heater. You'll also find details on what to consider when it's time to go comparison shopping for a new water heater—including an evaluation of the alternatives to the common gas or electric storage tank unit that's found in the majority of homes in Iowa and across the country.

Get going now, but take time to plan for the future

You don't have to spend a lot to generate considerable savings on your water-heating bills. Start by making sure your existing water heater is properly maintained. Talk with everyone in your family about how they can reduce hot-water use on a daily basis. Fix the little problems, such as water leaks, that can add up to wasted dollars much faster than you'd ever imagine. And be realistic about the lifetime of your water heater; once it's seven to ten years old (or out of warranty), begin your research into new models and make plans to replace the old one. Don't wait until the water heater fails, like many people do; at that moment, you'll be reacting to a home emergency that may force you into making quick, uninformed decisions that will cost you money in the long run.

How much of the work can you do?

If you're a competent do-it-yourselfer, you can manage many of the energy-saving projects and maintenance chores described in this book. However, if you're uncomfortable with the idea of working on plumbing or would rather hire someone to handle an upgrade or repair, don't hesitate to call a professional; the dollars saved through energy savings in future years will be worth the expense. (Of course, only a trained technician should tackle jobs that require working with natural gas, propane, electricity or electronic water heater control units.)

Look for rebates and tax credits

Many utility companies offer rebates on high-efficiency gas or electric water heaters; in addition, some local electric cooperatives offer special pricing on energy-saving electric water heaters for customers who convert from gas models. Look for the latest offers on your utility's Web site or call the company's customer service department.

Also check the Database of State Incentives for Renewable Energy (DSIRE) at <http://www.dsireusa.org>, which features a comprehensive listing of local, state, federal and utility incentives that promote renewable options such as solar water heating systems.

A tax credit can provide significant savings, too, after you buy a qualified energy-saving water heater. However, unlike a rebate, a check for the tax credit won't arrive in your mailbox a few weeks after you make the purchase; instead, the tax credit will reduce the amount of income tax you'll pay for the year in which you put the equipment in service. Consult your tax adviser or go to the Web sites for the Tax Incentives Assistance Project at <http://www.energytaxincentives.org/> or the Alliance to Save Energy at <http://www.ase.org/>.

Energy use in a typical home

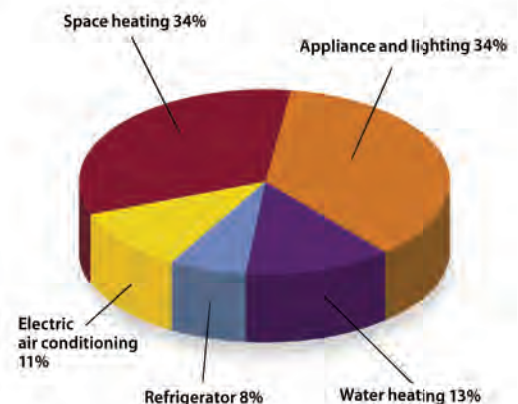

Ranking as the third-largest energy user in an average home, water heating accounts for about 13 percent of a family's utility bill.

Source: 2005 Buildings Energy Data Book, U.S. Department of Energy Office of Energy Efficiency and Renewable Energy

Take a systems approach to lowering water-heating costs

Your water heater is more than just an appliance sitting in a corner of your basement (or a utility closet)—it's an integral part of a whole-house hot water supply system that runs, at a minimum, to your home's kitchen, bathrooms and laundry. Every part of this system—whether it's a long pipe run from the water heater to a bathroom at the other end of the house or a leaky faucet at the kitchen sink—can have a dramatic effect on your monthly utility bills.

For example, you may need to run the water at a bathroom sink for a couple of minutes until it's finally hot enough for shaving; during that time, all the cool water that's been sitting in the pipe from the water heater just runs out of the faucet—and then down the drain. Or, if the hot water side of the kitchen faucet leaks a little bit around the handle whenever you run the water, you could be wasting a gallon or more of hot water every day—or more than 500 gallons of water a year. In an average home, that's enough water to fill your water heater 10 or 12 times; by any measure, that's a lot of wasted, heated water!

Study your home to save

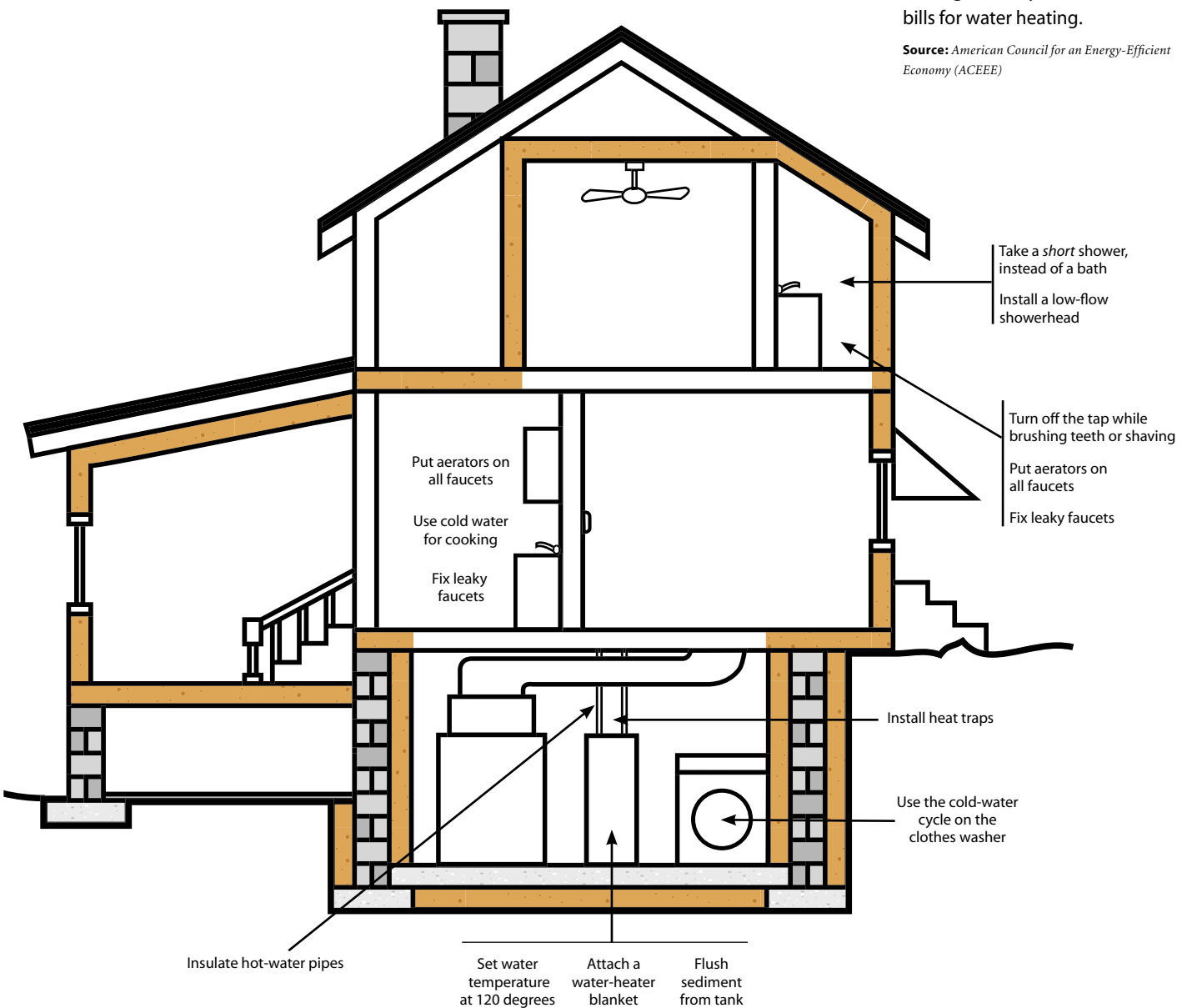

Hot water use in a typical home

Activity	Gallons per Use
Clothes washing	32
Showering	20
Bathing	20
Automatic dishwashing	12
Preparing food	5
Hand dishwashing	4

Reducing water use from these typical levels is one of the ways an average family can shrink utility bills for water heating.

Source: American Council for an Energy-Efficient Economy (ACEEE)

Go with the flow



Check to see if your shower is a good candidate for a low-flow showerhead with the help of a bucket and a watch with a second hand. Turn on the shower to the pressure you normally use, hold the bucket under the water flow and time how long it takes the water to reach the 1-gallon mark. If it's less than 20 seconds, your flow rate is more than 3 gallons per minute (gpm) and you should replace the showerhead.

? Did you know?

If you often need small amounts of hot water for cooking, you shouldn't let the kitchen faucet run for a couple of minutes. Instead, install an instant hot water dispenser at your sink. It operates just like a miniature tankless water heater—but can provide 190° F. water quickly for hot beverages, gravy or even soaking a food-encrusted pan.

Follow these steps to use less hot water

Saving water and reducing water-heating costs go hand-in-hand. In fact, for most households it's possible to **cut the amount of energy used to heat water by 25 percent to 50 percent**— just by implementing a few water-saving steps and increasing the hot-water system's overall efficiency.

Bathroom

Close the drain before you turn on the water to fill the bathtub.

Don't let the water run down the drain until it gets hot. Instead, close the drain and adjust the water temperature as the water level in the tub rises. If you can hear water leaking past the drain, replace it.

Fill the bathtub to the level you really need.

Small children require considerably less water than an adult; bathe babies in the sink.

Take a *short* shower, instead of a bath.

A bath generally uses more hot water than a shower, taking about 15 to 25 gallons of hot water; a short shower takes 10 gallons.

Install a water-saving, low-flow showerhead.

Older showerheads use 4 to 5 gallons per minute (gpm), while a new one uses 2.2 gpm and a water-saving unit uses 1.5 (or less) gpm. Water-saving showerheads vary in feel from a solid blast to needle-like, and some offer a "massage" feature that varies from pulsating to vigorously pounding. Look for a quality showerhead that fits your personal preferences, rather than an inexpensive unit that just restricts water flow—or you may end up with a fine, misty shower, instead of a usable water flow.

Add a shutoff button to the showerhead.

Some showerheads include this feature, which lets you conveniently stop the water flow while washing your hair or soaping up. If the showerhead you choose doesn't have a shutoff button, you can buy a shutoff fitting that goes between the shower pipe coming out of the wall and the showerhead.

Replace a leaking bathtub diverter spout.

If water continues to run from the tub spout (and down the drain) when you're taking a shower, you need a new tub spout.

Turn off the tap while brushing teeth or shaving.

You can lose between 5 and 10 gallons of water down the drain if you leave the water running. Instead, rinse your razor in a filled sink.

Wash your hands with cool water.

On average, about three-quarters of the water used in a home is hot water, so don't use heated water when you really don't need it!

Kitchen

Use cold water for cooking.

Heating the water on your stove or cooktop consumes less energy than using hot water from your water heater—especially if doing so causes your water heater to cycle.

For cold water from a single-handle faucet, push the handle right before starting the water flow.

Pushing the handle straight up (or to the middle position) can mix hot water in with the cold. In addition, the hot water supply pipe between the faucet and the water heater will fill with hot water, cycling your water heater and wasting energy before the water even gets to the faucet.

Washing dishes by hand? Rinse them in the unused half of a divided sink.

Rinsing dishes under running water—especially if it's warm or hot—uses much more water and energy than just dipping the soapy dishes in a sink partially filled with clean, cold water.

Laundry

Use the cold-water cycle on the clothes washer for most loads, and always use cold water for rinsing.

About 90% of the energy used for washing clothes is for heating water, so use the warm- or hot-water cycles only when absolutely necessary. Most fabrics will get clean if you use the proper cold-water laundry detergent in your washing machine.

Adjust the water volume to fit the load size in your clothes washer.

Run full loads or adjust the machine's water level control for smaller loads. Use less laundry detergent and fabric softener too.

Buying new appliances

Shop for an energy-efficient, water-saving dishwasher.

Consider both the initial purchase price and the lifetime operating cost of the appliance. Check the yellow EnergyGuide label that tells how much electricity the dishwasher will use annually, and look for an ENERGY STAR™ label signifying that the unit uses at least 25% less energy than the minimum federal standards. Also compare features, including water temperature booster heaters, computerized "smart" controls and gallons of water used per cycle.

Choose an energy-efficient, water-saving clothes washer.

Evaluate both the initial purchase price and the lifetime operating cost of the appliance. Examine the yellow EnergyGuide label to find out how much electricity the clothes washer will use each year. Pick an ENERGY STAR unit, signifying that the unit uses at least 50% less energy than minimum federal standards—and uses 18-25 gallons of water per load, instead of the 40 gallons consumed by standard machines. Also look for water level controls, suds-saver settings and cycle-length controls.

Around the house

For just a few dollars each, install aerators on all faucets in the bathrooms, the kitchen and the laundry.

An older faucet can deliver 2 to 4 gpm—new ones are 2 gpm or less—but a faucet aerator can reduce that amount to 1 or 0.5 gpm. In the kitchen, you may want to maintain a higher flow rate if you regularly fill large pots for cooking or use the sink for washing dishes. Some aerators include a shutoff valve that allows you to temporarily turn off the water without changing the hot/cold water mix.

Get unusually high water pressure under control.

If your home has unusually high water pressure, consider having a plumber install a pressure-reducing valve that can slow water flow by 20% to 50%. Reducing the pressure not only will save water, but also will help handle existing water hammer problems in your pipes.

You may have hidden leaks in your hot-water system. Find them by performing this test.

Locate the two water pipes coming out of the top of your water heater. One supplies cold water to the tank; the other is the hot water outlet. When you haven't used any hot water for a few hours, feel both pipes; their temperatures should be about the same. If their temperatures are notably different, repeat the test in a few more hours—making sure not to use any hot water in the meantime. If both pipes remain equal in temperature, you do not have a hot water leak. However, if only the hot water pipe is still warm, you do have a leak. The pipe will be warm all the way from the tank to the location of the leak.

Did you know?

To save water and energy, **let your dishwasher do its job.** Pre-rinsing dishes usually is unnecessary, and the energy-saving features that came with the appliance—such as air drying—can have a significant positive impact on your utility bills.

Get leaks under control

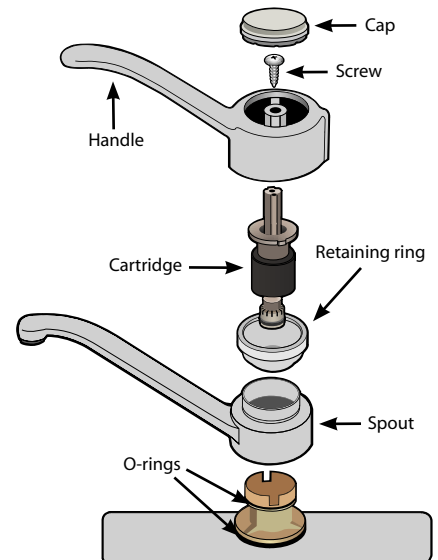

Leaky faucets waste a lot of water, energy and money. In fact, a leak that fills a cup in 10 minutes will waste more than 3,000 gallons of heated water every year.

- You can repair many faucet leaks by simply replacing some internal parts. Note the manufacturer and model number of your faucet, and take this information to a local hardware store or home center.
- If buying the parts to repair an older faucet costs almost as much as replacing it, buy a new water-saving faucet instead. Look for one with a lifetime warranty.

Give your water heater a blanket

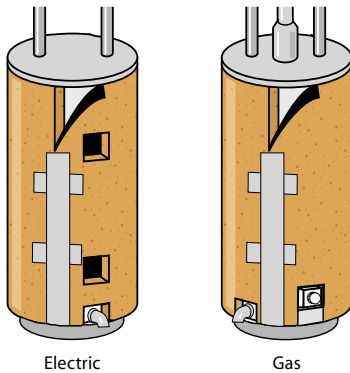

Wrapping an **insulation blanket** around the tank of your existing gas or electric water heater can save you money on water-heating bills. The insulation blanket will reduce standby heat loss—heat lost through the wall of the tank—by 25% to 45%, and you'll likely recover the cost of the blanket through reduced water-heating bills within a year.

- Check the owner's information that came with your water heater to make sure the manufacturer doesn't prohibit installing an insulation blanket.
- Look for a blanket with an insulation value of R-11 or higher.
- Buy a blanket kit designed for your type of water heater, and carefully follow the installation instructions. For example, on electric water heaters you should avoid covering the unit's thermostats. For gas water heaters, steer clear of the thermostat, air inlet at the bottom and the flue on top of the unit.

CAUTION!

The latest energy-efficient water heaters have very high insulation levels, which eliminates the need for adding an insulation blanket. In fact, the manufacturers of many super-insulated models recommend not adding any additional insulation to the tank and may void the appliance's warranty if you do so.

Increase your water heater's efficiency

In addition to cutting the demand for hot water, there are many things you can do to improve the efficiency of your existing water heating system. Some of these upgrades cost just a few dollars and will take you only a few minutes to complete—while others require a larger investment and installation by a professional technician—but all will pay for themselves through reduced utility bills during the normal lifespan of a water heater.

Insulate the hot water pipes

A great deal of energy and water is wasted—literally going down the drain—while you wait for hot water to reach the sink or shower. **Insulating your hot water pipes will help reduce heat losses** as the hot water flows to your faucet or showerhead, and it will help minimize standby losses when the tap is turned on more than once an hour. Even with insulated pipes, the water eventually will cool—but the water will stay warmer longer than it would if the pipes were not insulated.

Your hot water system is a good candidate for pipe insulation if:

- ▶ You use water frequently throughout the day; e.g., everyone in your home takes a shower in the morning, one right after the other.
- ▶ The water pipes in your home are long.
- ▶ The pipes pass through an uninsulated crawl space or basement.

These types of water pipe insulation are available:

- ▶ *Fiberglass batts.* These thin batts come on a roll, and wrap the pipe, securing the batt in place with tape as you go.
- ▶ *Foam or fiberglass tape.* Both types come on a roll, and they're self-adhesive so they'll stick in place as you wrap the pipes.
- ▶ *Foam or synthetic rubber tubes.* Commonly sold in six-foot lengths, these tubes are split lengthwise so all you do is slip them over the pipes and secure them. Some types are held in place with zip ties or tape, while others include self-adhesive strips along their cut lines. Rigid foam tubes usually have a higher insulation factor than the less-expensive flexible foam tubes, but the flexible ones are easier to trim and cut for corners or T-joints in pipe runs.

Before you go shopping, measure the length and diameter of the water pipes you want to insulate. You may need a couple of sizes if you're planning to insulate both the main hot water supply line (often 3/4-inch pipe) and the branch lines (1/2 inch) to individual fixtures and appliances. At the store, you'll need to balance cost, convenience of installation and insulation factor; for example, even though fiberglass insulation may have a higher R-value than foam tubes, it costs more and will take longer to install—and its payback period will be longer.

Vacuum the dust and debris off the pipes before you begin installation; wear safety glasses to keep any remaining debris that gets knocked loose from falling in your eyes; for fiberglass insulations, wear gloves and a dust mask too. Insulate the first six feet of both the hot and cold water pipes, starting where the pipes go into the water heater. Also insulate the hot water pipe runs that go to frequently used fixtures or appliances.

Add a timer or load controller to an electric water heater

A **timer** may save you money but before investing in one, contact your utility company to see if it offers a **water heater load-control program**. If it does, the utility will have an automatic means of turning off your water heater during specified time periods, so you won't need to install a timer. If your utility doesn't have an automatic way to shut off your water heater but still offers off-peak rates, then a timer could provide savings.

A timer that shuts down your water heater during the day when no one's home or at night when everyone's asleep will cost around \$50 plus professional installation, so it may take over a year to pay for itself. Timers for gas water heaters with pilot lights are not nearly as useful or as cost-effective because the flame is always burning, limiting the savings.

“Thermosiphoning” is a word you need to know

Metal is an excellent conductor of heat, and both hot and cold water pipes offer a thermal shortcut for escaping heat. You can observe this phenomenon by placing your hand on the hot and cold water pipes leading from your water heater at varying distances from the tank. Both pipes probably will be warm, which is a sure sign of unwanted heat loss.

Heat is carried out of the tank by the movement of hot water mixing with cold water in the pipes—called **thermosiphoning**—even when no water is being drawn out of the taps. Hot water is buoyant, so it tends to rise in any vertical pipe, such as the main hot water line. That hot water then releases its heat to the pipe (and the air surrounding the pipe) until the water cools and sinks back down into the tank.

The best way to prevent this type of heat loss—called a **convection loop**—is to install **anti-convection valves** on the pipes leading into and out of the tank. The simple, one-way valves go where the pipes attach to the tank and prevent cooled water from settling back into the tank and being replaced by hot water. The best time to have a plumber install anti-convection valves is when the water heater is being replaced; the savings in water-heating costs may not be enough to justify the expense of installation on an older water heater.

A less-expensive alternative—especially if you know how to work with copper pipe—is to install **heat traps** in the cold-water pipe leading to the tank and the hot water pipe going away from it. These traps are made from copper pipe and are almost as effective as anti-convection valves; however, heat traps probably are not a cost-effective choice if you have to pay for professional fabrication and installation for an existing water heater.

Stop dumping dollars down the drain

Most of the energy used to heat water goes down the drain, so recapturing that warmth and reusing it makes sense. According to the U.S. Department of Energy, installing a **drain waste-water heat recovery system** can produce energy savings of 25 to 30 percent for water heating.

This system uses a heat exchanger to absorb the heat from water flowing through the drainpipes of sinks, showers, bathtubs and appliances. The reclaimed heat then preheats the cold water flowing into the water heater, so the water heater doesn't have to cycle as long to heat the water to the set temperature. This has two benefits that result in energy (and cost) savings: recycling the warmth from water already heated and cutting the recovery time for a storage tank water heater (or the cycling time of a demand/tankless or solar water heating system).

A whole-house drain waste-water heat recovery system is a good choice if you're building a new home or extensively remodeling one, because it will be difficult to install in an existing home. A heat exchanger assembly replaces the drainpipe at each often-used fixture or appliance. Some models are *passive* and work best with showers and other continuous-flow fixtures, while others are *active* and include a small electric pump to circulate the water from the heat exchanger at dishwashers and other batch-flow sources.

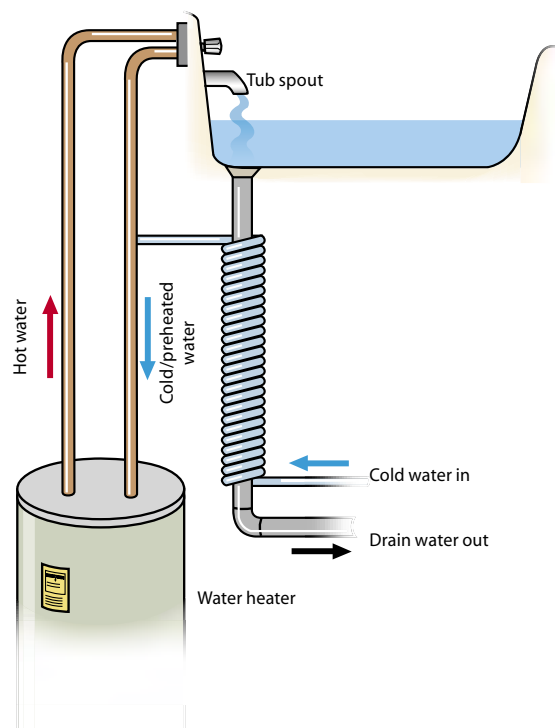

Keep hot water where it belongs

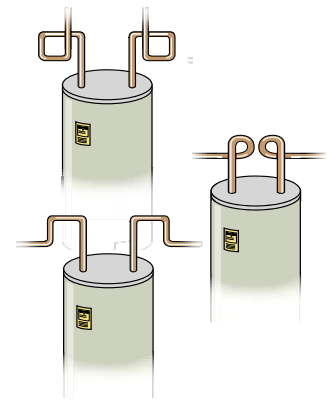

Heat traps fabricated from copper plumbing pipe can help prevent heat loss from a storage-type water heater.

Get hot water faster

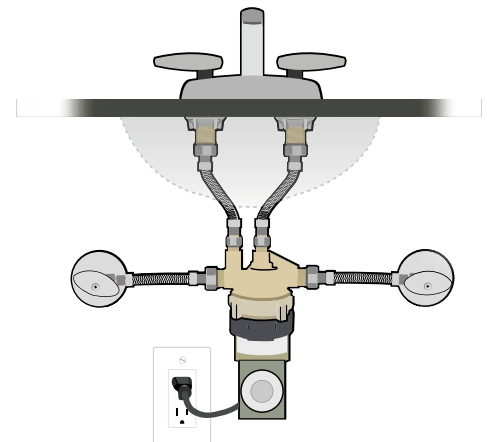

An automatic quick-delivery water-circulating unit can bring hot water to your faucet in seconds. When you open the hot water faucet, a small high-volume pump starts and within 15 seconds delivers hot water from the water heater through the regular hot water pipe. However, instead of just dumping the cold water in the pipe down the drain, a diverter valve in the device redirects it to the cold-water pipe. As soon as the hot water reaches the faucet, the valve closes and the pump shuts off. Some kits also include a timer, so you'll have hot water as soon as you get up in the morning and turn on the faucet.

CAUTION!

If the drainpipe connected to the **pressure relief valve** near the top of your gas or electric water heater tank is warm over most of its length (or there's a puddle on the floor underneath the pipe), the valve probably is leaking. You can check the valve yourself, but if you don't feel comfortable working around hot water that's under high pressure, get in touch with a plumber. Before replacing the valve, first try to flush it out by slightly moving the control lever attached to the valve and releasing a small amount of water. This sometimes will flush out the sediment stuck in the valve; if it doesn't, you probably will need a new one. *Note:* If the valve shows no signs of leaking, don't open it; otherwise, you may damage it and cause it to leak!

**Did you know?**

A gas water heater can tell you when **it's time to call a plumber or service technician**. For example, the burner should have a clean, blue flame; if it's mostly yellow, the burner may need to be cleaned or fine-tuned. If the pilot flame is mostly yellow, flickers or is more than about an inch long, it requires an adjustment. And if the pilot won't stay lit, the thermocouple probably has failed and needs to be replaced.

Regular maintenance makes a difference

There are a couple of things you can do to make sure you're getting the most out of your water heater now—and to help it last a little longer too. **Be sure to check the manufacturer's information booklet for special instructions before you start.**

Turn the knob, and save 10 percent on water heating costs

For most households, **a temperature of 120 degrees will meet your hot water needs**. This is well below the 140-150 degrees found in many homes. Excessively high water temperatures can cause these problems:

- ▶ The higher the water heater temperature, the faster the system will lose heat—and the longer the system will take to cycle.
- ▶ Higher temperatures increase the rate of corrosion on internal fittings and other surfaces, shortening the life of the water heater and other parts of the water heating system, including pipes, valves and faucets.
- ▶ Hot tap water is a scalding hazard, especially to children and seniors. Scalding occurs in two seconds at 150 degrees, while it takes 10 minutes for scalding by 120-degree water.

Each 10-degree drop in temperature will save three to five percent on water heating costs.

Most people find the 120-degree temperature to be satisfactory, especially considering that a "hot" shower usually runs around 105 degrees. However, if you have an older dishwasher that does not have a water-heating booster, a 140-degree temperature may be necessary for the appliance to effectively clean dishes, kitchen utensils and pots and pans.

Determine the hot water temperature by running hot water into a bowl for at least a minute and checking the temperature with a candy thermometer. If the temperature is higher or lower than 120 degrees, adjust the thermostat on the water heater a little bit, wait an hour and recheck the temperature.

For a gas water heater, turn the thermostat knob on the outside of the tank. Electric water heaters often have two thermostats—one for the upper heating element and one for the lower heating element. Before removing the access panels on an electric water heater to reach the thermostats, turn off the electricity at the circuit breaker panel. Adjust both thermostats to the same level to prevent one element from overloading and prematurely wearing out.

Finally, when you're going to be away from home for several days, turn the water heater thermostat down to the lowest setting or shut down your water heater.

Flush sediment from the tank twice a year

Sooner or later, rust and scale will build up inside the water heater's tank, making it work less efficiently. As the water heater cycles through hot and cold periods, it expands and contracts, causing rust and scale to drop to the bottom of the tank.

To remove the sediment, follow these steps:

- ▶ Following the water heater manufacturer's directions, shut down a gas-fired water heater or turn off the power to an electric unit, and allow the tank to cool.
- ▶ Close the cold-water supply valve, or shut off the water at the meter.
- ▶ Open a hot water tap in the house.
- ▶ Open the drain valve at the bottom of the tank and let the water flow until it's clear (usually three to five gallons); catch the water in a bucket or attach a short section of garden hose and run it to the nearest drain. If the valve is clogged, remove the stem and insert a small wire through the valve into the tank to get the water flowing.
- ▶ Close the drain valve, and open the cold-water supply valve. Don't close the hot water tap until all air is exhausted from the tank and water flows from the tap.
- ▶ Following the manufacturer's directions, relight the pilot light on a gas-fired water heater or turn on the power to an electric unit.

Is it time to buy a new water heater?

Across the United States, the majority of water heaters—well over 90 percent—are gas or electric storage tank units. That’s because their technology is proven, their cost is low and they’re locally available. However, this domination of the marketplace doesn’t mean that there aren’t other types of water heaters worth considering when it’s time for you to purchase a new one. You’ll find more details on these options on pages 14-15.

No matter which style of water heater you prefer, one thing is certain: **Choosing the most energy-efficient unit your budget allows will pay off long-term**, because the energy-cost savings you’ll realize will more than pay back the higher initial cost of purchasing a better water heater. In addition, carefully consider buying a water heater with the longest manufacturer’s warranty available; it will be priced a little higher, but likely will include upgraded insulation, better-quality internal parts and other premium features.

Think about a new water heater before you really need one!

Most people wait until their water heater breaks down before shopping for a new one. Since they’re in a hurry to restore their hot water supply, they usually don’t take the time to shop for the water heater that best meets their needs. They often make a bad choice, settling either for a water heater that’s on sale or the unit a local plumber “uses all the time.”

You can avoid this situation with a little planning. With water heater warranties ranging from six years to “lifetime,” **it’s difficult to predict exactly when a water heater will fail**. On average, it’s probably safe to say that a water heater will last from 10 to 15 years—or possibly longer, if it’s been properly maintained and regularly serviced. However, unless you’ve lived in your home for a long time, you probably didn’t choose your present water heater; the previous owners or a builder did. As a result, you may not know how old it is, how well it’s been maintained or even if the original warranty is still in effect.

If your present water heater is showing obvious signs of old age—rust around the bottom of the tank or leaks starting to develop—you need to act immediately. But if your water heater is functioning properly and you believe it’s at least seven years old, take a little time to evaluate your hot water needs and begin comparing the various types and models on the market today—which will help you make an informed and energy-wise purchase tomorrow.

Even if your older, but inefficient, water heater is functioning properly, consider replacing it with a new, energy-efficient one. The energy savings alone could pay for the new unit within a few years, and you’ll be happy knowing that you’re dumping fewer pollutants into the air and sending less money down the drain.

Size is not the most important consideration

You may be inclined just to look for a new water heater that’s the same size as the one you have now—replacing the old 40-gallon storage tank unit with a new 40-gallon one. That could be an expensive mistake.

For example, what if your family is growing? You’ll soon need a higher-capacity water heater. Perhaps you bought a new home—just for the two of you—that previously was occupied by a large family. You might be able to downsize the water heater or switch from a tank-style unit to a tankless device. In addition, you may want to consider a solar water heating system.

On the other hand, size could be an issue if the space for your water heater is limited—especially if the unit is located in a closet. Some of the new super-insulated water heaters are larger in diameter than their older counterparts and may not fit in the same space. In addition, many storage tank water heaters get taller as their gallon capacity increases, and gas-fired units with power venting units on the top need a little extra headroom too.

Read the EnergyGuide label

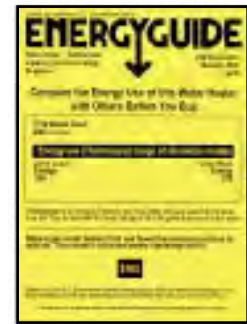

Use the EnergyGuide label to compare the operating costs of water heaters you’re considering. Each label shows estimated annual energy consumption, how a particular water heater measures up against comparable ones and estimated annual operating cost.

Did you know?

The U.S. Department of Energy's Web site includes links to **water heating calculators** to help you:

- Estimate the lifetime energy savings of electric and gas water heaters that have varying levels of energy efficiency.
- Investigate the price, savings and system size of solar energy systems to produce electricity, heat household water and warm up a spa or pool.
- Determine your present water heater's energy usage and estimate whether a solar water heater could save you money.

To find the calculators, go to http://www.eere.energy.gov/consumer/calculators/water_heating.cfm.

Will your new water heater recover in time?

The first thing to consider when replacing a storage tank water heater is your need for hot water and its relationship to a number called the **first hour rating** (FHR). The first hour rating is the amount of hot water a unit can heat during the highest-demand hour of the day; some people call it “recovery time.” (Other types of water heaters use different ratings.)

This rating takes into account the tank size and how quickly cold water is heated. In some cases, a water heater with a small tank—but a powerful burner—can have a higher FHR than a water heater with a large tank and less-powerful burner. In addition, as the size of a tank increases, the standby losses of the unit also go up because the tank has a greater tank surface area. And if the system is a gas-fired unit, it also will lose some heat energy up the flue.

Estimate peak hour demand

The chart below will help you estimate your family's hot water use for the busiest hour of the day—the family's **peak hour demand**—not the total amount of hot water everyone uses in a day. Please note that the values in this table do not consider the installation of water-conservation measures such as low-flow showerheads, faucet aerators, a front-loading clothes washer or other devices that can reduce hot water use for each activity.

Hot water use	Hot water gallons per use	Times used in 1 hour	Gallons used in 1 hour
Showering	20	x	=
Bathing	20	x	=
Shaving	2	x	=
Washing hands and face	2	x	=
Hand dishwashing	4	x	=
Automatic dishwashing	10	x	=
Preparing food	5	x	=
Clothes washing	32	x	=
PEAK HOUR DEMAND			=

Source: Gas Appliance Manufacturers Association and ACEEE estimates

Choose a water heater with a capacity within a couple of gallons of this peak demand. In the following example, the family uses 66 gallons of hot water first thing in the morning, making either a 50-gallon electric water heater or 40-gallon natural-gas unit with an FHR of at least 66 a good possibility. A rule of thumb is: The quicker a unit can heat water, the smaller the tank needed; the longer it takes a unit to heat water, the larger the tank needed. Tank construction, insulation thickness, controls and many other factors differ from one water heater to the next and affect the FHR, so compare all specifications and options when you go shopping.

Activity	Hot water gallons per use	Times used in 1 hour	Gallons used in 1 hour
3 showers	20	x 3	= 60
1 shave	2	x 1	= 2
Hand-wash dishes	4	x 1	= 4
PEAK HOUR DEMAND			= 66

Source: Gas Appliance Manufacturers Association and ACEEE estimates

Look for efficiency too

Once you have determined the size of the storage tank water heater you need, the next step is to **decide which type and model is the most fuel-efficient**. The unit's energy factor (EF) is the best indicator of a water heater's efficiency, measuring it based on the following criteria:

- ▶ *Recovery efficiency*—how efficiently the heat from the energy source (gas, electricity or oil) is transferred to the water.
- ▶ *Standby losses*—the amount of heat lost through the tank walls and pipes.
- ▶ *Cycling losses*—the extra energy expended in the starting and stopping of the burners (on gas units only).

The higher the EF rating, the more efficient the heater will be. An EF of 1.00 would mean that a water heater converted 100 percent of the input energy into heated water. Practically speaking, the best electric storage tank water heaters have an EF of around .95, while the top-rated gas-fired ones are below .70. For comparable sized units, electric water heaters generally show higher numbers, because heat loss occurs only through the tank; gas units also experience losses through pilot light waste, burner operation and heat energy exhausting up the flue.

The units with the highest EF typically have the most tank insulation and incorporate heat traps, but larger tanks often have lower EFs. The manufacturer's literature usually lists the EF rating, or it can be found on the yellow EnergyGuide labels on the water heaters.

Low price doesn't necessarily equal long-term value

It may be tempting to simply buy the cheapest model and ignore **operating costs**, but this strategy will be costly in the end. Often the least-expensive water heater to buy is the most expensive to operate. In addition, you really have to give some thought to long-term energy costs, especially if you're thinking about replacing your current water heater with one that uses a different fuel or energy source.

Make the water heater the center of attention

If possible, **locate the water heater near the middle of your home**—or close to the hot water taps, fixture or appliances you use most often. This will lessen the opportunities for heat loss that occur in long pipe runs. Also try to minimize the length of pipe runs to your kitchen, bathrooms and laundry.

In addition, a storage tank water heater will lose less heat if it's placed in a conditioned space—but don't put it in an area that will increase the air-conditioning load on your home. On the other hand, don't install the water heater in an unheated basement.

Installing a water heater is not a job for most home do-it-yourselfers

Devote a significant amount of time to finding the right installer; make sure the company has experience with the type of water heater you've chosen. Ask friends, neighbors and business associates for recommendations.

Look at written bids from at least three licensed and insured local contractors, and evaluate their estimates carefully. Ask when payment is due and by what methods—and make sure all of these items are included in the price: a statement guaranteeing that all work will meet current plumbing and/or building codes; permits (if required); draining, disconnecting and hauling away the old water heater; connecting, filling and testing the new unit; and cleaning up the work area. Before you make a final decision on what company will do the work, check references and call the local Better Business Bureau to see if there are any complaints on file.

Where's the ENERGY STAR label?

After the latest federal standards raised the minimum energy factor (EF) for water heaters, ENERGY STAR determined that the incremental savings offered by the best gas and electric water heaters would not be large enough to justify awarding an ENERGY STAR designation to them. In fact, the rating differences between the top-performing storage tank water heaters and the least-efficient ones would be smaller than in any other ENERGY STAR appliance category. In addition, the organization felt that "nonconventional" water heaters were not yet well proven, their pay-back periods are unreasonable for average consumers and their availability is too limited.

Other organizations have discontinued their popular listings of the most energy-efficient water heaters for some of the same reasons. However, consumer magazines still run product reviews that provide helpful and detailed information about various brands of water heaters.



Heat traps are essential

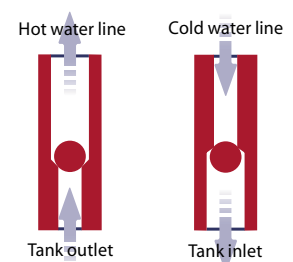

If **anti-convection valves** or **heat traps** for both the cold-water inlet and the hot water outlet are not included with your new water heater, make sure the installer adds them.

Look for special features

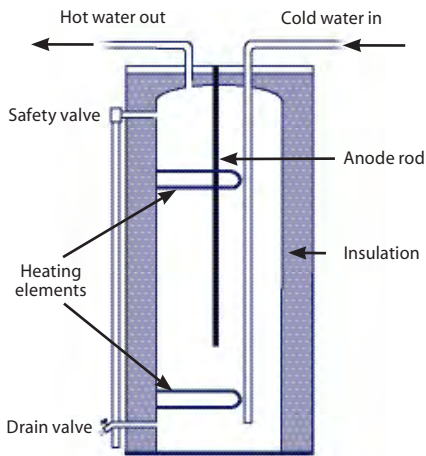

Besides the standard electric storage tank water heater shown here, there are units with extra choices you may want to consider. One type has “smart” controls with multiple modes you can set, including one that tells the computer inside to automatically adjust the water temperature to match your family’s hot water usage; this reduces standby losses when no hot water is needed. The other kind has a lifetime warranty and includes a polyethylene outer shell and a seamless molded plastic tank inside; the wide spacing between them is filled with foam insulation—even at the top, where it’s needed most.

Did you know?

If you live in an area where the mineral content of the water is high, you can prolong the life of a water heater by installing a **sediment trap** or a **water softener** in the cold water line before it goes to the water heater.

Should you choose an electric or gas-fired unit?

By a wide margin, storage tank water heaters are the most common type of water heater used in homes, and they typically range in capacity from 40 to 60 gallons. They’re powered by electricity, natural gas or liquid propane.

In an environment of fast-changing energy prices, it’s difficult to recommend one type of water heater over another. However, one thing is certain: Spending a little time to complete the peak hour demand chart and water heating calculators on page 10 will help you make the most economical choice after evaluating all costs—purchase price, energy consumption and maintenance—for the **lifetime** of your new water heater. In addition, if you’re thinking about changing to a water heater that uses a different energy source than the one you have now, be sure to include all of the conversion costs in your long-term calculations.

No matter what their energy source, all storage tank water heaters operate in pretty much the same manner. The tank is surrounded by a blanket of *insulation* and is enclosed in a *metal* or *polymer (plastic) jacket*. Cold water from the water service flows through an inlet at the top of the tank and goes down an *internal supply pipe* to the bottom of the tank. A pair of *heating elements* (electric) or a *burner* (gas) heat the water in the tank. When a tap is opened, hot water exits through an *outlet* on top of the tank; at the same time, cold water flows into the bottom to replace the outgoing heated water. A *thermostat* keeps the water at the requested temperature.

Three other components have special functions. A *pressure relief valve* located on top of the tank (or on the side, near the top) prevents excess pressure buildup in the tank caused by overheating; the valve opens to release the pressure if water inside overheats to a dangerous level. An *anode* hanging in the water in the tank helps prevent tank corrosion. And a *drain valve* near the bottom of the tank allows you to regularly drain a few gallons of water from the tank to remove rust and sediment buildup.

Most electric water heaters require 240 volts

The energy factor (EF) rating of an electric water heater will be higher than that of a comparably sized gas water heater. An electric unit also is easy to turn off and on.

Some utilities offer special rebates on the purchase of an electric water heater—or low-block, off-peak or load-management programs that can lower the rates you pay for energy. Be sure to check on these potential money savers before you purchase a water heater.

Keep these things in mind when you go shopping

Look for these features when you’re comparing electric storage tank water heaters:

- ▶ Long-lasting heating elements made from special materials other than standard copper.
- ▶ A magnesium anode rod that will last longer than a mild-steel anode rod.
- ▶ CFC-free tank insulation rated at R-24 or insulation that’s at least three inches thick.
- ▶ A specially coated ceramic- or porcelain-lined tank that resists corrosion more effectively than a standard glass-coated tank.
- ▶ A sediment-reduction system—such as a dip tube that creates turbulence in the tank—to reduce lime and sediment buildup.
- ▶ The longest standard manufacturer’s warranty that’s available. Sometimes the tank has different warranty than the water heater’s other components—possibly even a lifetime warranty. Most water heater warranties cover replacement parts but don’t include labor costs to replace failed parts. Also check to see if the warranty will transfer to the new owners if you sell your home.
- ▶ Heat traps to prevent heat loss caused by siphoning of heated water into pipes.
- ▶ A brass (not plastic) drain valve.

There are two types of gas unit to consider

A natural gas or propane water heater generally will be less efficient than an electric one, with an EF for the most-efficient gas models running about .62. A gas unit can lose up to a quarter of its heating energy during the combustion process while heating the water; much of the waste heat just goes up the flue and out the chimney. On the other hand, a natural gas water heater may be less expensive to operate than an electric unit when lifetime energy costs are considered. In addition, utilities may offer special rebates or energy pricing that will have a favorable effect on the long-term cost of owning a gas water heater.

For all types of gas water heaters, **appropriate venting is essential** for proper operation and your family's safety. The *standard vent* that comes with most basic gas-fired water heaters is a simple unit that directs combustion byproducts through a flue that passes through the middle of the tank, up the chimney and out of your home. However, if you live in a very airtight house, the flue is extremely long or the water heater is located in a conditioned space, choose a water heater with a *power vent* that uses a fan to carry the exhaust outside; you probably will need to add an outside air intake for improved combustion too. Finally, a *direct vent* that combines the exhaust flue and an outside-air intake into a single unit might be a good choice if locating the water heater along an outside wall makes sense in your home. Since a direct vent relies on natural air currents—there's no fan involved—the vent only can extend about four feet from the water heater to the outside of the house.

Keep these things in mind when you go shopping

Look for these features when you're comparing gas storage tank water heaters:

- ▶ A super-efficient, sealed combustion chamber with a burner that reduces nitrous oxide (NO_x) emissions.
- ▶ Compliance with flammable vapor ignition resistant (FVIR) standards that prevent unintended ignition of flammable vapors from products such as solvents, cleaning products, gasoline, aerosol sprays and adhesives.
- ▶ Viewing window to check burner function.
- ▶ Piezoelectric (pushbutton) or electronic pilot light igniter.
- ▶ A magnesium anode rod that will last longer than a mild-steel anode rod.
- ▶ CFC-free tank insulation rated at R-16 or insulation that's at least two inches thick.
- ▶ A specially coated ceramic- or porcelain-lined tank that resists corrosion more effectively than a standard glass-coated tank.
- ▶ A sediment-reduction system—such as a dip tube that creates turbulence in the tank—to reduce lime and sediment buildup.
- ▶ The longest standard manufacturer's warranty that's available. Sometimes the tank has a different warranty than the water heater's other components—possibly even a lifetime warranty. Most water heater warranties cover replacement parts but don't include labor costs to replace failed parts. Also check to see if the warranty will transfer to the new owners if you sell your home.
- ▶ Heat traps to prevent heat loss caused by siphoning of heated water into pipes.
- ▶ A brass (not plastic) drain valve.

Your home needs a CO detector on every level

Carbon monoxide (CO) is an invisible, odorless and colorless gas created when fossil fuels such as natural gas, propane or oil burn incompletely. The best way to prevent CO poisoning is to properly install CO detectors in your home. Look for alarms that have been certified by an independent testing laboratory (such as UL), and follow the manufacturer's instructions for installing them. If an alarm sounds, open the windows immediately to ventilate the area and move everyone outside to fresh air. Then call your fire department and utility; they will bring test equipment to locate the source of the CO.

Consider the recovery time

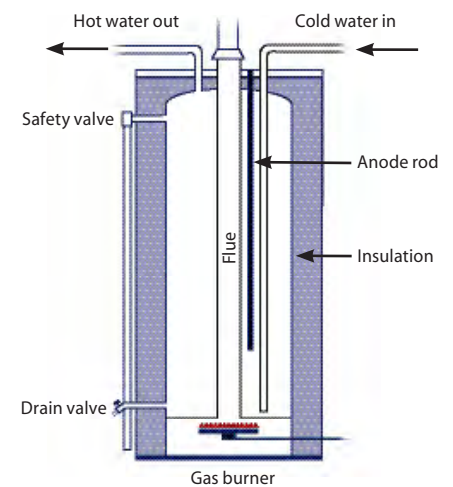

In a natural gas or propane storage tank water heater, the burner sits below the water tank—but within the insulated shell of the unit. In most cases, recovery time for a gas water heater will be shorter than that of an electric unit.

? Did you know?

Installing an energy-efficient heating-and-cooling system in your home can make your new gas water heater an "orphan." If your home now is very airtight—and you've installed an air-source heat pump, a geothermal heat pump or a gas forced-air heating system that uses outside air for combustion, the exhaust fumes from the water heater may not properly flow up the chimney that originally was sized to handle exhaust from both the water heater and the old gas furnace. (During cold weather, the exhaust from the water heater may condense on the inside of the chimney flue and run back into your home too.) To fix this situation, have a technician install a chimney liner to reduce the flue's volume or choose a power-vented water heater.

Instant hot water

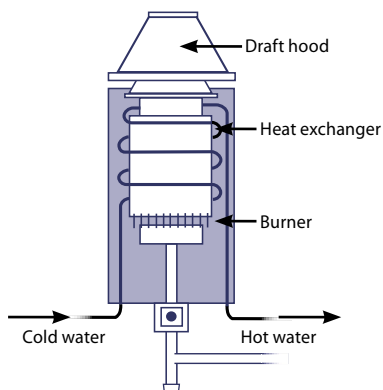

A tankless water heater can be a sensible choice in a home occupied by just one or two people—or a family with a schedule that doesn't require multiple hot water uses at the same time.

? Did you know?

Freestanding **heat pump water heaters** disappeared from the marketplace almost as fast as the devices came into it. They were expensive, fairly unreliable and needed a boost from electric heating elements to produce sufficient hot water for an average family—especially in cold weather. However, some of the manufacturers of heat pump water heaters turned their attentions to serving larger, commercial customers with great success, so it's probably only a short matter of a time before new-and-improved, energy-saving and practical units are released again for homeowners.

Demand is growing for tankless water heaters

Ten years ago, tankless water heaters—also called *on-demand* or *instantaneous* water heaters—mostly were a curiosity in the American marketplace. But a new push for energy efficiency (plus significant recent improvements in the performance characteristics of these devices) makes **whole-house tankless units** worth a second look for some homeowners.

Where's the water storage tank?

A tankless water heater isn't much larger than a briefcase, and it heats water only when there's a demand for it. The cold water enters the unit and passes through a heat exchanger, where it's heated by a high-powered electric element or gas burner. An electronic control unit keeps tabs on the water temperature and flow rate, shutting down the unit when hot water no longer is requested; however, **the unit will continue to provide hot water as long as it's needed**, unlike a storage tank water heater that needs time to recover before it can supply another tankful of hot water. Typically, a gas tankless unit heats faster and more efficiently than an electric one.

A tankless water heater is rated by **flow rate**—the number of gallons of hot water it can produce per minute at a particular temperature increase. And therein lies a problem: A tankless water heater cannot provide large amounts of hot water at the same rate as a conventional water heater can, meaning the tankless unit may not be a good choice for a family that uses more than one shower—or the clothes washer and the dishwasher—simultaneously. On the other hand, a tankless unit could provide all the hot water needed if each shower or appliance was used one after the other. Tankless systems are most effective when water-saving showerheads and faucet aerators are in use.

The greatest disadvantage of a tankless unit is the cost of purchasing and installing one. The price for a unit that can adequately service a typical household will be much higher than for a storage tank water heater, and—depending on your family's size and water-using habits—its payback will take much longer too.

Another drawback for an electric tankless water heater is that a home may need upgraded electrical service, since a tankless unit draws a lot of power when it's in operation—more than 100 amps for some units. Typical residential wiring often will not support a tankless electric water heater with a large enough capacity to serve multiple uses—and the operating costs for an electric unit are higher than those of a gas one—so if you rely on electricity to heat your water, a tankless system is unlikely to meet your needs.

Use your air conditioner to heat water

An air-conditioning system can heat water with the addition of a **desuperheater**—a heat-recovery unit that captures waste heat from a central air conditioner, air-to-air heat pump or geothermal heat pump and uses it to preheat the water in a storage tank water heater. There are two basic types of desuperheater.

When you add a desuperheater to a **central air conditioner or air-to-air heat pump system**, the desuperheater can provide hot water at little or no cost—and improve the efficiency of the air conditioner when the unit is in use. **Because the desuperheater only works when the air conditioner is running** (five to seven months of the year), a backup water-heating source is necessary for cool- and cold-weather months. An add-on desuperheater is relatively expensive, too, so the payback period for the unit in Iowa will be pretty slow. Ask a heating and cooling contractor for a detailed analysis on whether a desuperheater makes sense for your home, and make sure adding one will not void your existing cooling system's warranty.

Is it practical to heat water with the sun?

Although there are many types of solar water heating systems available, the best choice for Iowa homeowners is either an **indirect circulation** or **drain-back** system. In the indirect closed-loop system, a small electric pump regulated by a system controller circulates a non-freezing heat-transfer fluid such as a glycol-water antifreeze mix through a roof-mounted solar thermal collector. The fluid then moves from one or more collectors down to a heat exchanger that's located in an insulated solar storage tank, preheating the water before it flows to a conventional gas or electric storage tank water heater. This water heater is used for backup on cloudy days and for times of unusually high demand for hot water. The drain-back system works in a similar way, except the liquid in the collectors and exposed pipes drains into an insulated reservoir tank each time the circulation pump shuts off.

To get the most out of a solar water heating system in Iowa, **the collectors need an unobstructed, south-facing view of the sun for as much of the day as possible**—at least three hours before and after solar noon. Shading from neighboring trees, a building next door or even a chimney or parts of the roof upon which the collector sits will reduce the system's effectiveness.

On a bright and sunny day, you won't need to install a huge array of collectors on your roof to provide enough hot water for a family of four. In fact, a solar thermal collector measuring about 64 square feet should handle the needs of a family of four. (Figure 20 square feet of collector for the first two family members, and add 12-14 square feet for each additional person.) For storage tank capacity, figure 1.5 gallons per square foot of collector size.

A well-designed, properly installed and maintained solar water heating system typically can supply up to half of the annual water-heating needs for a typical family. While the initial cost of a solar water heating system is high, utility company rebates and/or tax credits can shorten the system's payback period by a significant amount. You will realize the greatest financial benefit from a solar water heating system if you have a large water heating load and currently heat water with electricity and pay high electric rates—or if you use propane.

Good sources of information on solar energy topics include the Florida Solar Energy Center (<http://www.fsec.ucf.edu>), the American Solar Energy Society (<http://www.ases.org>) and the Energy Efficiency and Renewable Energy in Iowa page from the U.S. Department of Energy (http://www.eere.energy.gov/states/state_specific_information.cfm/state=IA). In addition, you can get a rough idea of the potential cost, energy savings and system size for a solar water heating system installed in a home in any county in the U.S. at Find Solar (<http://www.findsolar.com>). **Before you buy solar equipment, make sure the components are certified and rated** by the nonprofit Solar Rating and Certification Corporation; for details, go to the organization's Web site at <http://www.solar-rating.org>.

Indirect circulation system

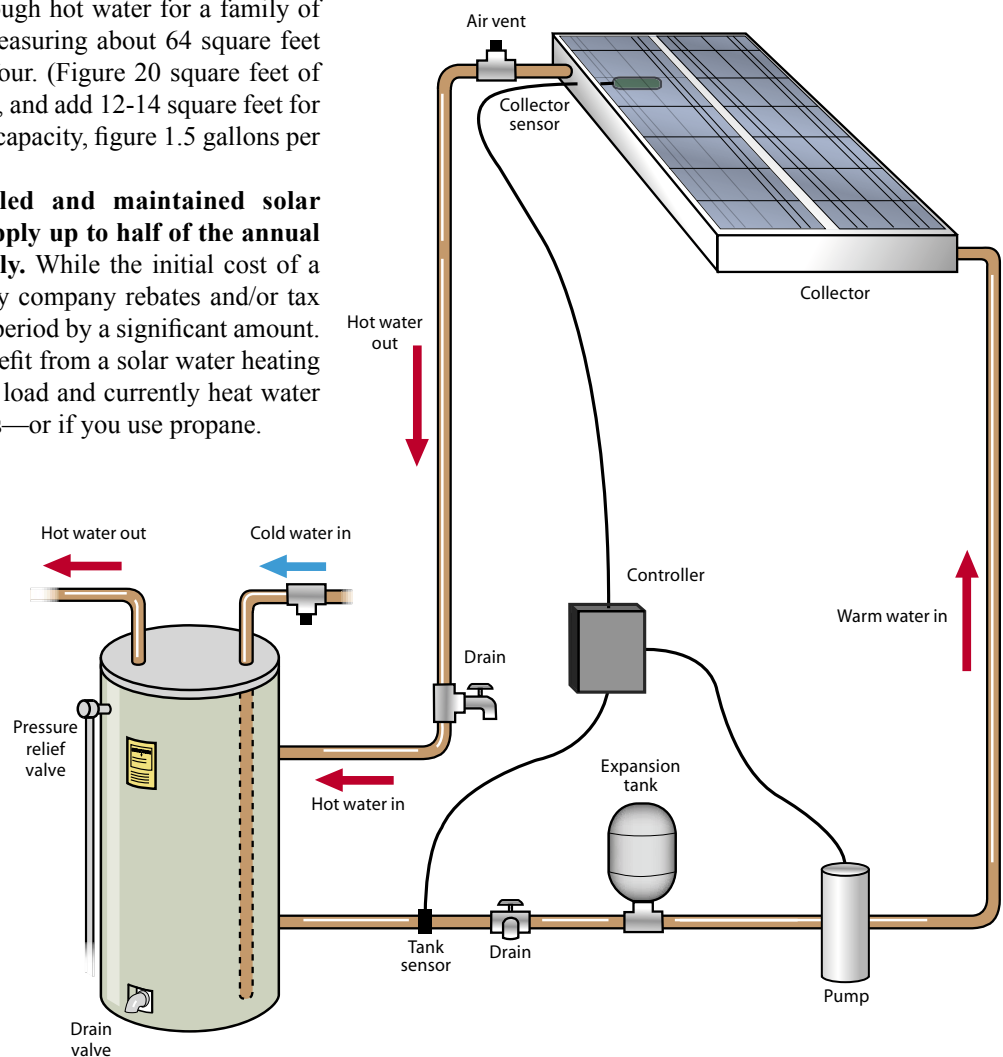

Alliance to Save Energy

1200 18th Street NW, Suite 900
Washington, DC 20036
Phone: 202-857-0666
Web site: <http://www.ase.org/>

Alliant Energy

4902 North Biltmore Lane
P.O. Box 77007
Madison, WI 53707-1007
Phone: 800-255-4268
Web site: <http://www.alliantenergy.com/>

American Council for an Energy-Efficient Economy

1001 Connecticut Avenue, NW, Suite 801
Washington, DC 20036
Phone: 202-429-8873
Fax: 202-429-2248
Web site: <http://www.aceee.org/>

Aquila, Inc.

1701 48th Street, Suite 260
West Des Moines, IA 50266
Phone: 816-421-6600
Web site: <http://www.aquila.com>

Atmos Energy Corporation

24 South 10th Street
Keokuk, IA 52632
Phone: 888-824-3434
Web site: <http://www.atmosenergy.com/>

Energy Efficient Rehab Advisor

Web site: <http://rehabadvisor.pathnet.org/>

ENERGY STAR

1200 Pennsylvania Avenue, NW
Washington, DC 20460
Phone: 888-782-7937
Web site: <http://www.energystar.gov/>

Home Energy Saver

Environmental Energy Technologies Division
at the Lawrence Berkeley National Laboratory
Web site: <http://hes.lbl.gov/>

IowaENERGY.org

Web site: <http://www.iowaenergy.org/>

Iowa Association of Electric Cooperatives

8525 Douglas, Suite 48
Des Moines, IA 50322-2992
Phone: 515-276-5350
Fax: 515-276-7946
Web site: <http://www.iowarec.org/>

Iowa Association of Municipal Utilities

735 NE 70th Avenue
Ankeny, IA 50021-9353
Phone: 515-289-1999
Fax: 515-289-2499
Web site: <http://www.iamu.org/>

**Iowa Department of Human Rights/
Division of Community Action Agencies**

Lucas State Office Building
Des Moines, IA 50319
Phone: 515-281-0859
Fax: 515-242-6119
Web site: <http://www.dcaa.iowa.gov>

Iowa Department of Natural Resources

502 E. 9th Street
Des Moines, IA 50319-0034
Phone: 515-281-5918
Web site: <http://www.iowadnr.com/>

Iowa Renewable Energy Association

P.O. Box 3405
Iowa City, IA 52244-3405
Phone: 563-432-6551
Web site: <http://www.irenew.org/>

Iowa State University Extension

Answer Line Phone: 800-262-3804
Web site: <http://www.extension.iastate.edu/>
answerline/
or <http://www.extension.iastate.edu/housing/>

MidAmerican Energy

666 Grand Avenue
P.O. Box 657
Des Moines, IA 50303-0657
Phone: 888-427-5632
Web site: <http://www.midamericanenergy.com/>

**U.S. Department of Energy Office of
Energy Efficiency and Renewable Energy**

Mail Stop EE-1
Department of Energy
Washington, DC 20585
Phone: 877-337-3463
Web site: <http://www.eere.energy.gov/>

U.S. Environmental Protection Agency

1200 Pennsylvania Avenue, NW
Washington, DC 20460
Phone: 202-272-0167
Web site: <http://www.epa.gov/>



This is an Iowa Energy Center publication.

The Iowa Energy Center is a research, demonstration and education organization dedicated to improving Iowa's energy efficiency and use of renewable energy. The Energy Center meets its goals by developing in-house energy research and education programs and by sponsoring energy projects developed by other groups. The projects supported by the Energy Center, which vary in size and complexity, are conducted throughout the state in Iowa's universities, colleges, community colleges and private nonprofit organizations.

Iowa Energy Center

2521 Elwood Drive, Suite 124, Ames, IA 50010-8229
Phone: 515-294-8819 | Fax: 515-294-9912 | E-mail: iec@energy.iastate.edu
Web site: <http://www.energy.iastate.edu>



Major Home Appliances

4



- 🏠 **Save energy** by tuning up your existing appliances
- 🏠 **Cut your power bill** with a new refrigerator—page 4
- 🏠 **Cook up some energy savings** in your kitchen—page 8
- 🏠 **Control your clothes washer's appetite** for water—page 10

Is it time to buy new appliances?

If you haven't been in the market for new appliances during the past several years, you're going to be surprised at how innovative and energy-efficient appliances have become. **You'll find energy-smart appliance choices in almost all price ranges.**

Before heading to the local appliance retailer or “big-box” store, measure the space the new appliance will occupy to make sure it will fit—and that there's enough room to fully open the door (or lid), as well as adequate clearances for ventilation, plumbing connections and other hookups. Then go to the appliance manufacturers' Web sites to look at product information, and make a list of questions and “must-have” and “nice-to-have-but-not-essential” features.

Energy use in an average home

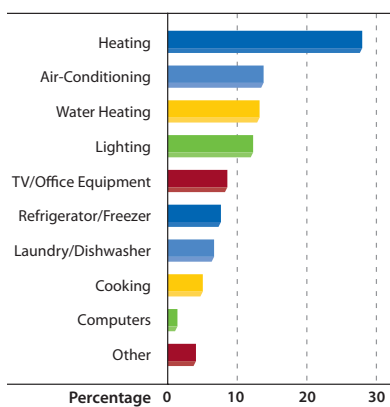

Added together, appliances are responsible for about 20% of a typical household's energy use. The numbers for appliances could be cut by 40%-50% if all older appliances were replaced with today's best energy-efficient models.

Source: U.S. Department of Energy Office of Energy Efficiency and Renewable Energy

Follow this shopping strategy for each appliance

With the measurements, questions and features list in hand, head for the store, and:

- ▶ Look at product brochures and the actual appliances to evaluate the features, performance capabilities and capacities of different brands and models. Ask questions about how different models operate. Are they noisy? What safety features do they have? What about repair histories? How much water do they use? How do the energy-saving cycles work?
- ▶ Check the operating manuals for the models on display. This not only will tell you how each appliance operates, but also can help you ask pertinent questions about regular maintenance and care. Also make sure the appliance's operation meets your family's needs and, for kitchen appliances, will accommodate your favorite cookware.
- ▶ Consult the yellow EnergyGuide labels to compare the annual energy costs of different models; look for ENERGY STAR® labels too. The more energy an appliance uses, the more it will cost to run; the difference on your utility bill could be significant.
- ▶ Uncover both price tags for the appliance—the one for the *purchase price* and the one for the *operating cost* (utility bills plus maintenance expenses). Consider both in evaluating the real cost of the unit.
- ▶ Read the warranty before finalizing your decision. Does the warranty cover the entire product or only certain parts? Is labor included? How long does the warranty last?
- ▶ Find out the cost of delivery, installation and removal of the appliance you're replacing.
- ▶ Make sure authorized factory service is available in your area for the unit you select.
- ▶ Finally, ask about manufacturer rebates, special local financing programs and energy-efficiency incentives from your local utility.

When your new appliance is delivered, check the exterior for dents and scratches and make sure no components such as drawers, shelves or special fittings are damaged or missing. If it's not part of your purchase agreement to have the delivery crew hook up and test the appliance, do it yourself and immediately report any problems to your salesperson.

Even if you're not ready to buy new appliances, read on

Each section in this book begins with tips for squeezing the most productivity from every unit of energy (and every gallon of water) being used by your existing appliances. Some are simple maintenance tasks the average homeowner can handle without calling a service technician. Others may suggest a change of behavior, such as running only full loads in the dishwasher or clothes washer to reduce the amount of energy used by the water heater. (By the way, almost all of these tips also apply to new appliances.)

The bottom line is a pretty simple one: **The more energy efficient an appliance is, the less it costs to run—and the lower your utility bills will be.** Using less energy is good for the environment, too, in terms of reducing air pollution and conserving natural resources.

Refrigerators

Get more from your refrigerator's energy use

Your refrigerator (or refrigerator-freezer, since most people buy a combination unit) is the only appliance that works continuously in your home—day after day, all year long. According to ENERGY STAR®, that makes it the largest single user of electricity in your kitchen—especially if it's an older unit using two or three times as much electricity as models available today.

So, **it's important to keep the refrigerator running at peak efficiency**—and to help everyone in your family recognize that they can have a major impact on the amount of electricity it consumes. Incidentally, most of these ideas apply to upright or chest-style freezers too.

Think efficiency

Keep the refrigerator door closed.	Every time you open the door, about 30 percent of the cool air tumbles out.
Check the temperature in the refrigerator and freezer.	Leave an appliance (or outdoor) thermometer in each compartment overnight. The refrigerator temperature should be 35-38 degrees; the freezer temperature should be 0-5 degrees.
Keep your refrigerator and freezer compartments full.	Food (and even containers filled with water or ice) will retain the cold temperatures better than empty spaces. As a result, the compressor will run less often.
When you close the door, give it a little extra push.	Make sure the door gasket seals completely by gently pushing on the door. Check the door visually too.
Clean the condenser coils once or twice a year.	After unplugging the unit, pull it away from the wall and use a vacuum cleaner or soft brush to remove dust from the condenser coils underneath (or on the back of) the appliance.
Keep the top of the refrigerator clear.	Don't use the top of the refrigerator as a storage spot. To work at peak efficiency, the refrigerator needs plenty of ventilation space around it to release the hot air produced during cooling cycles.
Let your refrigerator breathe.	Prevent heat and dust buildup that will cause your unit to run more often by leaving about three inches of open space on both sides and the top of the refrigerator's cabinet. (And don't use those spaces to store items such as step stools, flattened cardboard boxes, TV trays or brooms.)
Move your refrigerator to a cooler location.	Keep your refrigerator away from heat sources such as furnace ducts, baseboard heaters, the dishwasher and cooking appliances. Also make sure the sun doesn't shine directly on it through a window or door.
Allow cooked foods to cool before putting them in the refrigerator.	Adding hot foods to the refrigerator will make the compressor run overtime to compensate for the higher temperatures. Use shallow containers so the foods will cool more quickly.
Use lids or tops on all food-storage containers.	Moisture from foods and liquids evaporates in the refrigerator compartment, causing the compressor to run longer.
Turn off the "power saver" or "winter/summer" switch.	This switch is designed to prevent condensation from forming on the outside of the cabinet during the summer. Leave this feature off unless you discover you really need it.

Use a dollar to save a few more bucks

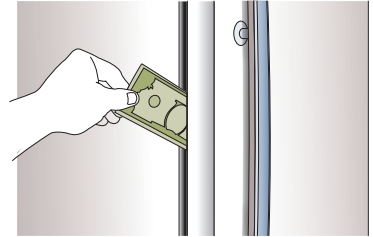

To check for air leaks in refrigerator door gaskets, close the door on a dollar bill or strip of paper in several locations around the perimeter of each door. If you easily can remove the bill (or it falls out), the gasket needs to be adjusted—or, more likely, replaced.

Also perform a visual check of the gaskets, looking for breaks or deformed areas that may not be sealing properly—or traces of mildew that indicate air leaks.

CAUTION!

Some refrigerator and freezer maintenance chores—such as defrosting the freezer, cleaning condenser coils or replacing some door gaskets—are easily handled by a competent home do-it-yourselfer. But if your refrigerator or freezer won't hold the correct temperature, is making strange noises or just isn't operating properly, call a professional service technician for help. Jobs such as recharging the coolant, replacing the compressor or repairing control units are best left to the pros.

Look for the labels

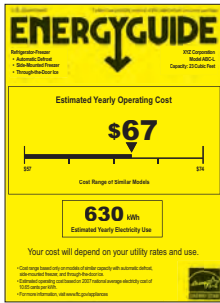

The Federal Trade Commission requires a yellow **EnergyGuide** label on most home appliances that shows an estimated yearly operating cost, along with estimated electricity and/or gas usage. The label also shows the highest and lowest cost estimates of similar appliance models.

Also look for an **ENERGY STAR** logo, which signifies that an appliance meets strict energy efficiency criteria established by the U.S. Department of Energy and the U.S. Environmental Protection Agency. The ENERGY STAR standards significantly exceed the minimums required by federal energy-efficiency standards.

For the latest information on ENERGY STAR qualified appliances (including updates in qualification standards and a list of products by manufacturer), go to www.energystar.gov.

How does a refrigerator earn its ENERGY STAR?

It really doesn't make sense to purchase a refrigerator or freezer that isn't ENERGY STAR qualified.

They use high-efficiency compressors, state-of-the-art insulation and precise temperature control systems to improve energy efficiency without sacrificing the features you want.

To qualify for the ENERGY STAR rating, conventional refrigerators and refrigerator/freezers larger than 7.75 cubic feet must be 20% more energy efficient than required by the current federally mandated standards.



Cut your power bill with a new refrigerator

New refrigerators are much more energy-efficient than older models. On average, the latest ENERGY STAR® qualified refrigerators use about half as much electricity as pre-1993 models.

The bottom line is pretty simple: Investing in a high-efficiency refrigerator now could have such a significant effect on reducing your monthly power bills that **you'll be able to recover the purchase price of the new unit long before it has outlived its usefulness.**

There are many energy-saving and convenience features

When you go shopping for a refrigerator, you're going to be confronted with a lot of information about energy-saving technologies—some worthwhile and some not—as well as a seemingly unending list of convenience and “nice-to-have” features.

Look for the ENERGY STAR label on the yellow-and-black EnergyGuide on every refrigerator you're considering; they're the best indicators of the appliance's predicted energy use. But watch out for refrigerators with names or features that sound as if they may be “energy savers”—especially if their EnergyGuide labels reveal them to be among the highest energy consumers of comparably sized units.

Generally speaking, the operating cost for one large refrigerator always should be less than that of two smaller units totaling the capacity of the bigger one. That's an important consideration if you're building a home or remodeling your kitchen and considering a small built-in refrigerator in the kitchen for daily use—and a second refrigerator (or freezer) in the pantry for longer-term storage.

Before you hit the stores, **make a list of things you liked about the refrigerator you're replacing, as well as features you'd like to have in a new one.** For example, most consumers gladly will pay for the convenience of an automatic-defrosting refrigerator, even though it will use a little more energy than one that needs to be defrosted manually every month or so. Was your old refrigerator large enough for your family, or do you need a bigger one? If you're empty nesters, is it time to downsize to a smaller unit? Consider accessibility, too, for people with special needs or limited reach; a side-by-side refrigerator/freezer may use up to ten percent more energy than other styles, but it could be a necessity for someone in a wheelchair—or the most practical choice for a family with kids who are old enough to grab a juice box or a snack without assistance.

Focus on capacity, style, features and real cost

Besides measuring the size of the available space—height, width and depth—for the refrigerator, consider the **capacity** (in cubic feet) you need. Around 20 cubic feet is a good starting point for an average family of four; if you do a lot of entertaining or freeze large quantities of food, add a few more cubic feet.

Note that the advertised size of most refrigerators is for the empty refrigerator and freezer compartments—without shelves, hardware or spaces behind drawers or in corners you can't use. Also keep in mind the special space needs for things such as your favorite beverage containers, serving trays and boxes for leftover pizzas.

When considering **style**, you have three basic choices. A *top-mount* refrigerator (with the freezer on top) will be a little more energy-efficient than a *side-by-side* unit, but you may give up convenience; the side-by-side configuration works better in small kitchens and offers better accessibility to both the refrigerated and freezer compartments. A *bottom-mount* refrigerator puts the freezer under the refrigerated section; some models use a pullout drawer, which prevents food from tumbling out when you open the door.

You'll also find variations of these styles, including units with bottom freezers and side-by-side doors for the refrigerator above—sometimes called “French door” refrigerators—and even four-door models that let you determine the use and temperature of the compartments. If you're remodeling your kitchen or building a new home, you might want to consider refrigerators



Top-mount



Side-by-side

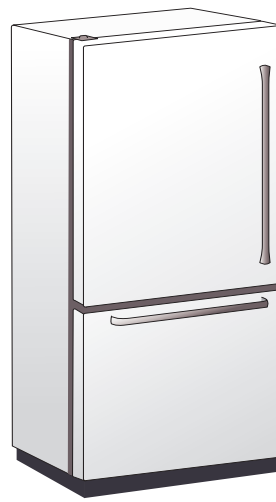

Bottom-mount

erator drawers that fit into standard cabinet spaces and eliminate the need for a conventional refrigerator. And if you're considering a cabinet-depth, built-in model or a large "commercial" unit, make sure you have enough space around it for adequate ventilation; otherwise, the compressor will work overtime (and waste energy) during the cooling cycle.

Some **features** can help reduce energy usage, while others simply make a refrigerator easier to use. For example, a unit with side-by-side doors may include an ice and cold-water dispenser in one of the doors, which eliminates the need to open the freezer door (and let the cold air inside escape)—but it uses a little more energy than a refrigerator without a dispenser. Special drawer systems with separate temperature and/or humidity settings can help you keep different types of food fresher for longer periods. And an automatic moisture control can help prevent moisture from building up on the exterior of the cabinet on high-humidity days without using an energy-wasting heater.

Like other appliances, every refrigerator has two prices that make up its **real cost** of ownership: one for *purchase price* and the other for *operating cost*. The purchase price is a onetime expense, but the operating cost runs for the lifetime of the refrigerator—an average of 13 years.

For a refrigerator, the operating cost includes monthly electricity charges and maintenance. To estimate power costs, use the EnergyGuide label that's required by law to be posted on every new refrigerator. Maintenance costs are a little harder to estimate; check with the appliance store's service department, talk with friends who have appliances from the same manufacturer or take a look at annual consumer guides or magazines.

Your old refrigerator isn't doing you any favors

Keeping your 15- or 20-year-old refrigerator in operation after you buy a new one may seem like a good idea—especially if it's paid for and still seems to be working fine. However, the reality is that **the old appliance may be costing you a lot more than it's worth**; in fact, if you really need the cold-storage capacity of a second refrigerator (or freezer), you'll likely be better off buying a new, low-cost, ENERGY STAR qualified unit.

To check the predicted operating costs of your present older refrigerator (especially if you're thinking about replacing it and keeping it for use in the garage or basement), check the *Recycle My Old Fridge Campaign* in the Appliances section at the ENERGY STAR Web site (www.energystar.gov). All you have to do is enter your refrigerator's model number and the amount you pay per kilowatt-hour of electricity.

Save energy without spending a lot—or buy an energy-wise top-of-the-line model

When you compare the retail prices and EnergyGuide labels on several refrigerators, you'll soon discover that *affordable* doesn't necessarily mean *featureless*. For example, the EnergyGuide labels shown here are for ENERGY STAR qualified refrigerators at opposite ends of the price scale.

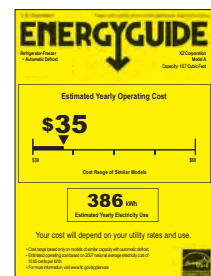

This label—for a basic, 15.7-cubic-foot, all-white unit that retails for around \$600—shows an estimated yearly operating cost of \$35. This automatic-defrost refrigerator includes a top-mount freezer and desirable features such as door storage for milk, encased condenser coils that don't require cleaning and a quiet design that significantly reduces operating noise.

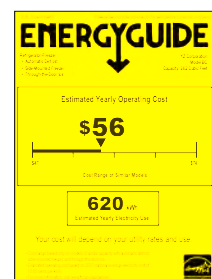

At the other end of the spectrum, the significantly larger, 26.2-cubic-foot, side-by-side stainless-steel model sells for about \$3,000 more—and costs an estimated \$56 to run for a year. It includes a full range of convenience features, including a door-mounted icemaker that saves valuable storage space; an indirect cooling system that prevents dehydration, freezing or frosting of produce; and an antibacterial door gasket.

Freezers, compacts and coolers

What about wine coolers and beverage chillers?

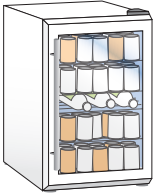

Unlike conventional and compact refrigerators, countertop, under-counter and freestanding wine- and beverage-cooling appliances aren't

required to show an EnergyGuide label—and none have been qualified by ENERGY STAR. Depending on what they'll be storing, these coolers include an adjustable thermostat and generally operate within a narrow temperature range of about 38-65 degrees.

However, you still can make an energy-smart choice when buying one of these units. Look for a cooler that uses a thermoelectric or Peltier cooling system—a small, solid-state heat pump that is much more efficient than a conventional compressor. In addition, choose a unit with an external temperature control and digital display—and LED interior lighting instead of a heat-producing incandescent lightbulb.

CAUTION!

Make sure you have a **dedicated electrical outlet** of adequate capacity where you'll be installing your refrigerator or freezer. Most manufacturers of these appliances prohibit the use of extension cords, which easily can overheat and cause a fire hazard.

Is a separate freezer a good choice?

Before you go shopping, **realistically evaluate your family's need for a separate freezer for year-round use.** Many people buy a freezer for stocking up on bulk foods or game once or twice a year, and then let the appliance run half-full or mostly empty the rest of the time.

If you decide that a new freezer does make sense for your situation, make energy efficiency a top priority by looking for units that carry the ENERGY STAR® sticker and by comparing the EnergyGuide labels on the ones you're seriously considering. Also note that many of the energy-saving and maintenance tips for refrigerators on page 3 apply to freezers.

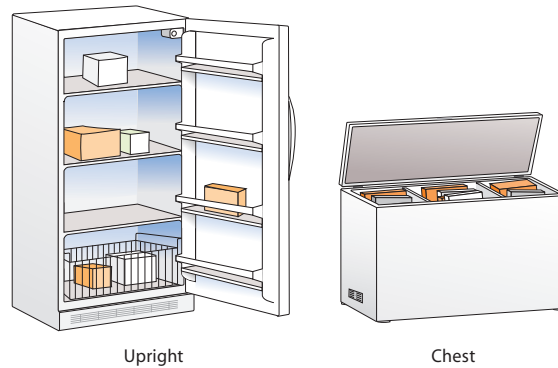

Upright

Chest

From a **style** standpoint, you have two choices. An *upright* freezer looks like a single-door refrigerator and is available in both manual- and automatic-defrosting versions. A manual-defrost freezer uses a little less energy, but most or all of its shelves will not be adjustable because they contain the tubes that carry the coolant throughout the unit. A self-defrosting upright costs a little more to operate, but many people think the added convenience is worth the extra expenditure—especially considering that you have to remove the food from a manual defrost unit and shut it down for up to 24 hours, unless it has a “quick-defrost” mode that heats the coolant tubes to melt accumulated ice.

On the other hand, a *chest* freezer of similar capacity will cost a little less to operate than either type of upright freezer. Most chest freezers require manual defrosting, which means removing all of the food inside, turning off the power and draining the water that accumulates in the bottom; only a few self-defrosting units are available.

No matter which style you prefer, even the most basic freezer should include an adjustable temperature control, an interior light to make it quicker to find foods, an exterior “power on” light, an alarm that sounds if the temperature gets too high and a door lock to keep kids out of the unit. For an upright freezer, also look for adjustable shelves, bins and door storage, which maximize convenience but reduce the usable capacity of the appliance. And for a chest freezer, check for a counterbalanced lid (so you won't have to hold it open with one hand while you're searching for a particular food item) and hanging or stacking baskets that make what's inside easier to organize.

You can save energy with compact refrigerators and freezers too

Looking for a compact refrigerator, freezer or combination unit to fit under a countertop in your family room or to send to a dorm room with a college student? Many of these compact appliances—ones less than 7.75 cubic feet in capacity and under 36 inches in height—are ENERGY STAR qualified and are at least 20 percent more efficient than required by federal standards. For more details on ENERGY STAR qualified compact units (including updates in standards and a list of products by manufacturer), go to the Appliances section at the ENERGY STAR Web site (www.energystar.gov).

Before you go shopping, make a list of the features you really need. For example, less-expensive refrigerator-freezers may have a tiny freezer shelf for storing a couple of ice trays, but higher-priced units may have a separate, zero-degree freezer. Some mini-fridges and freezers don't have adjustable shelves, so they won't hold two-liter or gallon bottles. Finally, look for a unit with automatic-defrost, adjustable thermostat and an easy-to-clean interior.

Dishwashers

Dishwashers: Push the right buttons to save

Most of the energy used to run a dishwasher isn't for powering the appliance; instead, it's for heating the water used by the dishwasher. So, if a new dishwasher isn't in the budget, **focus on making the most of your current machine's water consumption, in addition to reducing its energy use.** Also keep in mind that washing dishes by hand is not an energy-wise choice: According to ENERGY STAR®, in a year you'll save about 5,000 gallons of water and \$40 in utility costs by letting a dishwasher do the work.

Help your dishwasher do its job efficiently

Scrape (don't rinse) large pieces of food and bones.	Rinse, soak or pre-wash dishes only if food is dried-on, burned-on or extremely greasy.
Match the cycle selection to the load.	The normal setting will work best for most loads (even pots and pans).
Run only full loads.	A dishwasher can't vary the amount of water it uses based on load size.
Avoid using the rinse-and-hold cycle.	Depending on the age of your dishwasher, just rinsing the dishes could use several gallons of water.
Let the dishes air-dry.	If there's no air-dry button, stop the cycle after the final rinse and prop open the door. (Watch for escaping steam when you first open the door!)
Find the filter and clean it.	If your dishwasher doesn't have a self-cleaning filter, regularly remove it and clean out trapped food particles.
Clean the spray-arm nozzles and water jets.	Use a toothbrush to remove hard water deposits that can reduce the powerful flow of water necessary to clean dishes.
Use the delay-start setting.	Run the dishwasher late at night when some utilities offer reduced rates. Also avoid times when hot water demand is high, such as during morning showers or when preparing meals.

Buy a new one and save

You can save at least \$30 a year in utility costs by replacing a dishwasher manufactured before 1994 with an ENERGY STAR rated unit. In addition, features such as these help an ENERGY STAR qualified dishwasher use one-third less water than nonqualified models:

- ▶ *Innovative dish rack designs* that maximize cleaning by strategically positioning dishes.
- ▶ *More efficient water jets* that use less energy during the cleaning and rinse cycles.
- ▶ *A soil sensor* that judges how dirty dishes are and adjusts cycles for optimal cleaning and the most favorable energy and water use.

When you go shopping, you'll find standard-sized (24-inch-wide) and compact (18-inch-wide) under-counter models and portable units. In addition, you may see drawer-style units that let you run a small load in one drawer or a full load in both. **Besides comparing EnergyGuide labels for the units you're considering, look for dishwashers with a high Energy Factor (EF),** which measures electricity used to run the dishwasher and energy consumed to heat the water. The ENERGY STAR criterion is an EF of 0.65, which is 41 percent more energy efficient than the government's minimum standard of 0.46. Finally, consider features such as easy-to-set energy-saving and other cycle selections that match your family's lifestyle (like a gentle wash if you own a lot of glassware) and a tall tub for extra capacity if you have a large family.

Don't overload your dishwasher!

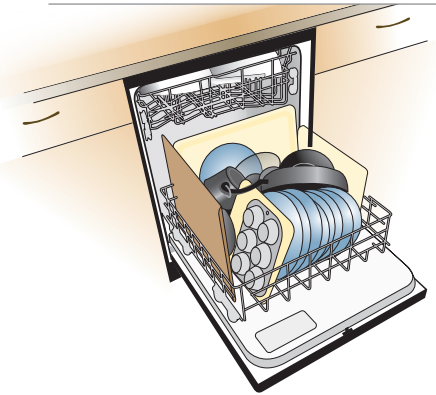

Everything in a dishwasher load must be exposed to the water spray and not interfere with the spray arms or water jets. Dishes, bowls and silverware that touch or "nest"—and cookie sheets or other large items that rest against the interior walls of the tub—won't get thoroughly washed or rinsed.

Did you know?

Almost all new dishwashers (and front-load clothes washers) include a booster heater that raises the temperature of the water from your water heater to the higher temperature needed for cleaning. As a result, you can lower your water heater's thermostat to an energy-saving 120 degrees, which is adequate for the needs of most families.

To check the temperature of the water coming from your water heater:

- Run hot water into a bowl from the faucet closest to your dishwasher for a minute or two.
- Check the temperature of the water with a candy or meat thermometer.
- Adjust the thermostat (or both thermostats, on many electric water heaters) as necessary.

Cooktops, ovens and ranges

CAUTION!

Freestanding ranges and improperly installed built-in ranges can tip forward if you put too much pressure on an open oven door. To prevent an accident, make sure no one in your family climbs or sits on the open door or uses it for support. In addition, make sure the proper anti-tipping device has been installed to secure the range to the floor or wall.

Cook up some energy savings in your kitchen

Whether you prefer gas or electric cooking appliances, make sure you're getting your money's worth from every energy dollar you spend in the kitchen. Besides the gains you'll see from properly maintaining your cooktop, oven and/or range, **you'll see the greatest savings on your monthly utility bills from modifying your cooking methods a little bit**—and getting rid of the bad cooking habits that waste more energy than they effectively use.

Don't let high energy bills for cooking appliances burn you up!

Add only as much water as necessary for cooking.	The more water you use, the longer it will take to heat. On the other hand, adding less water will allow you to use lower temperatures and shorten cooking times.
Choose pots and pans that fit the size of cooktop burners.	A 6-inch pot on an 8-inch burner loses about 40 percent of the burner's heat to the surrounding air. Conversely, oversized pots and pans won't heat efficiently, extending cooking times.
Downsize cookware whenever possible.	Use the smallest pot, pan or baking dish for the portion you're cooking.
Use flat-bottom cookware.	For the greatest heat transfer from an electric cooktop, cookware should rest flat on coil-style, solid, ceramic, halogen and induction elements.
Put lids on your pots and pans.	Lids help retain heat, allowing foods to cook faster and more efficiently. Your kitchen will stay cooler too.
Keep gas burners clean and adjusted.	A blue flame means proper combustion, but a yellow flame indicates service is needed to ensure that the gas is burning efficiently.
Wipe off the cooktop.	Baked-on spills can inhibit the heating of the burners, as well as reduce their lifespan. Also polish dirty burner pans under the burners so they reflect the heat, rather than absorb it.
Limit oven preheating.	Unless your oven automatically handles the preheating function, restrict preheating time to a maximum of 10 minutes.
Covering oven racks with foil is a no-no.	An oven works most efficiently when air can circulate within it. Stagger multiple pans to maximize air circulation too.
Check the oven with a thermometer.	Also monitor whatever you're cooking with the appropriate thermometer to make sure your oven's controls aren't wasting energy.
Watch cooking progress through the oven window.	Every time you open the oven door, the interior cooking temperature goes down by 25 to 30 degrees.
Make multiple meals in the oven.	It takes less energy to reheat meals than it does to cook them.
Use the microwave, instead of the oven.	You'll save up to 80 percent on energy costs and decrease the heat load in the kitchen too.
Cook or reheat small portions in a specialty appliance.	Lower energy consumption by using a toaster oven, mini-grill, pressure cooker, steamer or slow cooker. You'll reduce heat in the kitchen, too, which helps cut air-conditioning costs.
Inspect the oven door gasket.	If you find burned, crushed or damaged spots, replace the gasket to prevent heated air from escaping into the kitchen.

You don't have to be a pro to cook like one

Several years ago, the choices for cooking appliances were pretty simple. Did you want a separate cooktop and wall oven, or did you like the idea of a space-saving all-in-one range? Which of the four standard appliance colors was your favorite? And what style did you prefer, gas or electric?

Today, things have changed. Beyond making the decision on what cooking appliances you want (or need) to buy, you'll discover new cooking methods, a large palette of colors and a long list of options for all but the most basic models. So, plan on spending some quality time reading the manufacturers' brochures and visiting their Web sites.

However, beyond the claims the manufacturers make for the cooking methods of their products, **you won't see much information on the energy efficiency of these appliances.** Although the federal government has established minimum energy consumption standards for most major appliances, you won't find yellow EnergyGuide labels or ENERGY STAR® stickers on any cooktops, ovens or ranges. The reason? There are only small differences between the energy consumption levels of the top-performing cooking appliances and the least-expensive ones. As a result, it's up to you to determine which models will match your cooking style best and operate in the most efficient manner in your kitchen.

Cooktops: How many burners do you need?

Some people prefer **gas cooktops** because they believe gas burners offer more control over cooking times. If you fit into this category, some new styles offer five or six burners—or a continuous grate or “bridge” over the burners—making it easier to move pots and pans around the cooktop.

If you fall into the **electric cooktop** camp, you have a few choices beyond a standard unit with four *coil elements*. *Solid disks* take longer than coils to heat, but they're easier to keep clean. A heat-resistant ceramic glass cooktop with either *radiant elements* (a form of electric coils) or *halogen elements* (halogen lamps) under the glass offers a smooth, easy-to-clean cooking surface and is a little more energy-efficient than the first two types. And *induction elements* use electromagnetic energy to heat the cookware, not the cooktop. They're the most energy-efficient of all, but cost considerably more and require that you use iron or steel cookware.

By the way, if you can't decide between a gas and an electric cooktop, you can have both types of burners in a single cooktop: Ask for a **dual-fuel** model.

Ovens: Look for the right combination

While you still can buy a basic, single *built-in oven* (gas or electric), other choices might make cooking (and saving energy) more interesting for you. For example, you can specify a *convection oven*, which uses a fan to continuously circulate the heated air inside, cutting cooking times (and energy consumption). This method helps food cook more quickly and evenly; some models include an extra element for more-consistent heating. You also can add a high-capacity *microwave oven* to the mix, as an energy-saving alternative to the heat-producing ovens. And the best news is that you can mix and match one, two or all three of these technologies in a double-oven unit to meet your cooking needs.

Ranges: Choose a standard or high-tech version

If budget or saving space is a major consideration, look for a *freestanding range* or a *built-in range* that combines a cooktop and an oven. You can choose from gas, electric or dual-fuel models in a variety of cooktop and oven configurations. (Some premium 48-inch-wide models—a 30-inch width is standard—even include two ovens, one large and one small for baking.) For more cooking versatility without sacrificing too much space, consider adding a microwave oven with a built-in exhaust fan above the range.

Family meals require a full-sized microwave

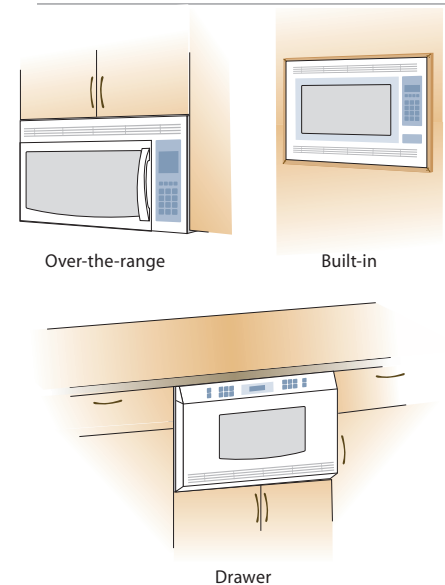

A small, 500-watt countertop microwave is fine for making popcorn or boiling water for tea, but if you're going to use the appliance for cooking complete meals, you need a model with a capacity of at least 1.5 to 2 cubic feet and 1,000 watts of power. You can choose from a variety of styles, including countertop, over-the-range with an exhaust fan, wall (cabinet) built-in or drawer.

Some types also are available as a combination microwave-convection oven, which includes a heating element and fan to circulate heated air throughout the oven and allows cooking options that closely match the results of a traditional oven.

Clothes washers and dryers

Did you know?

Iowa law requires that all “retired” appliances must be **demanufactured** to remove hazardous components before the metal parts can be recycled and the other components can be disposed of in an environmentally sound manner. There are numerous places in the state where you can recycle appliances; go to the Recycling and Composting page in the Waste Management section of the Iowa Department of Natural Resources Web site at www.iowadnr.gov, or call 515-281-5918 for more details.

As an alternative, many appliance dealers will handle the removal and disposal of an old appliance when they deliver a new one to a home. Be sure to ask if this service is available—and if there’s an additional charge.

CAUTION!

If you have a gas dryer, frequently check the exhaust vent to make sure it operates properly to prevent the buildup of dangerous (and potentially fatal) carbon monoxide (CO) fumes in your home. To be safe, install a CO detector in your laundry area.

Control your clothes washer’s appetite for water

Most of the energy consumed by a conventional top-load clothes washer is for heating the water for its wash and rinse cycles. So, **you can significantly reduce the amount of energy used** by choosing the cold-water setting and adjusting the water level to the lowest amount necessary for each load. In addition, carefully sort loads and pretreat tough or greasy stains so you won’t have to wash items twice. For more tips, check the owner’s manual.

Adjust the settings for each load

Wash full loads.	Combine half loads into full loads whenever possible; if you can’t set the load size, wait until you have a full load. (Check the owner’s manual for guidance on what constitutes a full load; you might even want to weigh a couple of loads to make sure.)
Don’t overload the washer.	If packed together too tightly, clothes and other items won’t get clean, because the water won’t be able to circulate properly.
Use cold water with a cold-water detergent.	In most cases, washing clothes and other items in cold water will get them clean. Cold water prolongs the life of most fabrics too.
If a cold-water wash doesn’t work, try warm—not hot.	Choose the warm-water cycle when necessary for extra-dirty clothes. Save the hot-water cycle for diapers or severely stained loads.
Use the right amount of detergent.	Using too much detergent can cause color fading and create excess suds, which the washer may not be able to rinse away during a normal cycle.
Choose a cold-water rinse.	Warm or hot water doesn’t rinse more effectively than cold.
Select an extended spin cycle.	This option will force the greatest amount of water from clothes, reducing drying time. (Note: This setting may not be appropriate for delicate and specialty fabrics.)

Buying a new clothes washer: You have more choices than ever

For many years, washers came in one style: a top-loading unit with a few knobs and buttons on the control panel. But today, you have a wide variety of choices in three categories:

- ▶ *Conventional top-loaders* have a traditional agitator and deliver solid washing abilities at a low initial purchase price—but, on average, have the highest energy and water costs.
- ▶ *High-efficiency top-loaders* don’t use an agitator, but consume less energy and water than conventional machines. However, top-loaders often have premium prices—but not the energy efficiency and water savings of front-loaders.
- ▶ *High-efficiency front-loaders* are the best choice for low energy use and reduced water consumption, but they cost more than the other types. However, your utility bill savings should more than make up the difference in initial purchase price during the first five or six years of ownership. In addition, front loaders use a high spin speed that effectively starts the clothes-drying process—so you can choose shorter, energy-saving cycles for the dryer.

When you’re comparing the specifications and prices of various washers, look for the capacity and features you really need; it’s possible to spend nearly twice as much for a machine with lots of bells and whistles (and indicator lights!) that performs essentially the same functions as a less-expensive machine. Be sure to evaluate whether a unit with extra sound insulation makes sense for your laundry setup too.

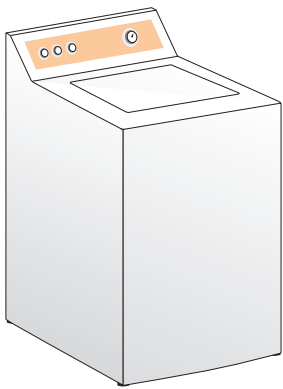

Conventional top-loader

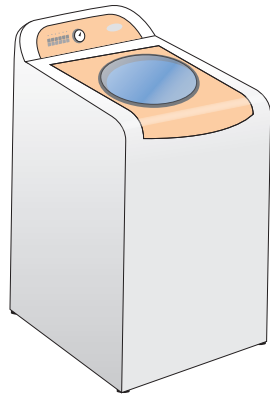

High-efficiency top-loader



High-efficiency front-loader

Then check the yellow EnergyGuide labels, along with each model's **Modified Energy Factor** (MEF), which takes into account energy used during the washing process, and **Water Factor**, which measures water use. (Look for a high MEF and a low WF.) For the model you choose to be ENERGY STAR® qualified, it must have a minimum MEF of 1.72 and a maximum WF of 8.0.

Use the dryer less, without sacrificing function

No matter if it's a gas or electric unit, **you can control your dryer's energy consumption.** Think about what you're including in each load. For example, the lightweight clothes will dry more quickly than the heavier ones, and the extra time the dry ones spend riding along with the heavier, still-wet ones may damage them—or at least cause extra wear and tear.

Adjust the settings for each load

Dry full loads.	Running a full cycle for a half load wastes energy.
Don't overload the dryer.	The dryer needs space for air circulation to efficiently evaporate the water caught in the fabrics.
Fluff bulky items as you load them.	Towels, sheets, jeans and other heavy clothing will dry faster if you separate and shake them before tossing them in the dryer.
Never overdry your clothes.	Overdrying can weaken fabrics and wastes energy. If your machine is equipped with a moisture sensor, use it.
Use the cool-down cycle.	This setting takes advantage of the residual heat left in the dryer at the end of the cycle and can substantially cut down on clothes wrinkling.
Clean the lint screen before every load.	Your clothes won't dry if the heated air in the machine can't circulate and vent properly.
Check the outside exhaust vent monthly.	If the vent is stuck shut, moist air can't escape and your dryer will run longer than normal to dry clothes. If the vent is stuck open, cold air can enter your home during winter months.
Regularly clean the moisture sensor near the drum.	Buildup from chemicals in fabrics and fabric softeners can limit the sensor's effectiveness, so gently clean it with a little rubbing alcohol on a cotton swab or rag.

? Did you know?

Flexible plastic and metal foil vent hoses can collapse and allow lint to accumulate, posing a serious fire risk. That's why dryer manufacturers recommend using rigid metal or flexible metal vents.

Thoroughly clean the dryer's vent system

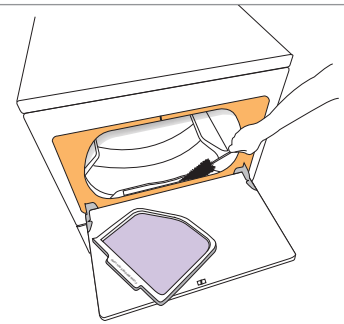

Every couple of months, remove the dryer's lint filter and use a skinny brush with a long handle to remove lint from inside the dryer's vent system. Brushes made for this purpose are available at hardware and discount stores for less than \$10.

Also clean the vent on the outside of your home, and make sure it opens and closes properly. Finally, clean the entire vent duct once a year or as needed—or call a professional to handle the job.

Alliance to Save Energy

1850 M Street, NW, Suite 600
Washington, DC 20036
Phone: 202-857-0666
Web site: <http://www.ase.org/>

Alliant Energy

4902 North Biltmore Lane
P.O. Box 77007
Madison, WI 53707-1007
Phone: 800-255-4268
Web site: <http://www.alliantenergy.com/>

**American Council for an
Energy-Efficient Economy**

529 14th Street, NW, Suite 600
Washington, DC 20045-1000
Phone: 202-507-4000
Fax: 202-429-2248
Web site: <http://www.aceee.org/>

Atmos Energy Corporation

2547 Hilton Road
Keokuk, IA 52632
Phone: 888-286-6700
Web site: <http://www.atmosenergy.com/>

Black Hills Energy

625 9th Street
Rapid City, SD 57709
Phone: 888-890-5554
Web site: <http://www.blackhillsenergy.com/>

Energy Efficient Rehab Advisor

Web site: <http://rehabadvisor.pathnet.org/>

ENERGY STAR®

1200 Pennsylvania Avenue, NW
Washington, DC 20460
Phone: 888-782-7937
Web site: <http://www.energystar.gov/>

Federal Trade Commission (FTC)

Consumer Response Center
600 Pennsylvania Avenue, NW
Washington, DC 20580
Phone: 877-382-4357
Web site: <http://www.ftc.gov/>

**Gas Appliance Manufacturers
Association (GAMA)**

2107 Wilson Boulevard, Suite 600
Arlington, VA 22201
Phone: 703-525-7060
Web site: <http://www.gamanet.org/>

Home Energy Saver

Environmental Energy Technologies Division
at the Lawrence Berkeley National Laboratory
Web site: <http://hes.lbl.gov/>

IowaENERGY.org

Web site: <http://www.iowaenergy.org/>

Iowa Association of Electric Cooperatives

8525 Douglas, Suite 48
Des Moines, IA 50322-2992
Phone: 515-276-5350
Fax: 515-276-7946
Web site: <http://www.iowarec.org/>

**Iowa Department of Human Rights/
Division of Community Action Agencies**

Lucas State Office Building
321 E. 12th Street
Des Moines, IA 50319
Phone: 515-281-3861
Fax: 515-242-6119
Web site: <http://www.state.ia.us/government/dhr/caa/>

Iowa Association of Municipal Utilities

1735 NE 70th Avenue
Ankeny, IA 50021-9353
Phone: 515-289-1999 or 800-810-4268
Fax: 515-289-2499
Web site: <http://www.iamu.org/>

Iowa Department of Natural Resources

502 E. 9th Street
Des Moines, IA 50319-0034
Phone: 515-281-5918
Web site: <http://www.iowadnr.gov/>

Iowa Office of Energy Independence

Lucas State Office Building
312 E. 12th Street
Des Moines, IA 50319
Phone: 515-281-0187
Web site: <http://www.energy.iowa.gov/>

Iowa Renewable Energy Association

P.O. Box 3405
Iowa City, IA 52244-3405
Phone: 319-643-3160
Web site: <http://www.irenew.org/>

Iowa State University Extension

Answer Line Phone: 800-262-3804
Web site: <http://www.extension.iastate.edu/answerline/>
or <http://www.extension.iastate.edu/housing/>

MidAmerican Energy

666 Grand Avenue, Suite 500
Des Moines, IA 50309-2580
Phone: 888-427-5632
Web site: <http://www.midamericanenergy.com/>

**U.S. Department of Energy Office of
Energy Efficiency and Renewable Energy**

Forrestal Building
U.S. Department of Energy
1000 Independence Avenue, SW
Washington, DC 20585
Phone: 877-337-3463
Web site: <http://www.eere.energy.gov/>

U.S. Environmental Protection Agency

Ariel Rios Building
1200 Pennsylvania Avenue, NW
Washington, DC 20004
Phone: 202-272-0167
Web site: <http://www.epa.gov/>



This is an Iowa Energy Center publication.

The Iowa Energy Center is a research, demonstration and education organization dedicated to improving Iowa's energy efficiency and use of renewable energy. The Energy Center meets its goals by developing in-house energy research and education programs and by sponsoring energy projects developed by other groups. The projects supported by the Energy Center, which vary in size and complexity, are conducted throughout the state in Iowa's universities, colleges, community colleges and private nonprofit organizations.

Iowa Energy Center

2521 University Boulevard, Suite 124, Ames, IA 50010-8629
Phone: 515-294-8819 | Fax: 515-294-9912 | E-mail: iec@energy.iastate.edu
Web site: <http://www.energy.iastate.edu>



Solar PV Energy Guide

5



- 🏠 Getting Started – page 4
- 🏠 Conducting a Site Assessment – page 9
- 🏠 Designing the Solar PV Array – page 13
- 🏠 Calculating the System ROI – page 24
- 🏠 Constructing the Solar PV Array – page 26

Solar PV Energy Guide

What is Solar Photovoltaic (PV) Technology and How Does It Work?

Solar PV technology is the process that converts sunlight into electrical current when it strikes suitable materials called semiconductors in a device. Sunlight is absorbed by semiconducting materials, such as silicon, releasing electrons from their atoms. The electrons flow through the semiconductor to produce direct current (DC) electricity.

The amount of Solar PV available to be converted to electricity can be impacted by various factors, including but not limited to seasonal conditions; the angle of the panel relative to the sun or number of daylight hours; atmospheric contaminants, including dust, humidity, and forest fires; cloud cover; and elevation.

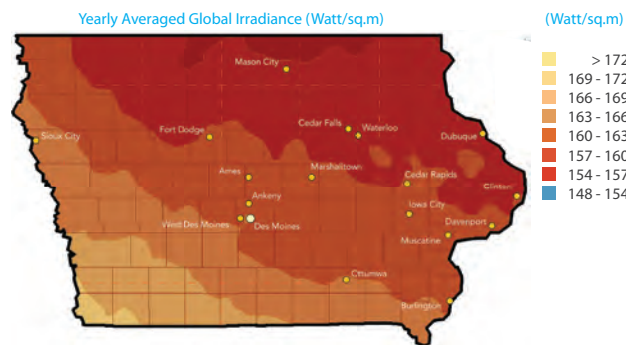

Building Blocks of a PV Array

A PV array is composed of solar modules, which are made up of solar cells. A solar cell is a semiconductor that converts sunlight into electrical energy and is rated between 1 and 4 watts depending on its efficiency. A solar module is made up of multiple solar PV cells that are wired together and sealed. Typically, a solar module is between ten and 320 watts (operating at 6 to 36 DC volts). A solar array is made up of multiple solar modules that are electrically wired together in one structure to produce a specific amount of power. A solar array can operate at up to 600 DC volts.

Solar cell technologies have evolved over time, and new technologies are continuously emerging. Understanding the advantages and disadvantages of each type of solar cell will help to ensure that you consider the appropriate technology for a potential installation.

The primary types of cells include:

- **Monocrystalline solar cells** are a first-generation technology, meaning that the technology, installation, and performance issues are well documented due to a more frequent use of this type of cell. These cells are the most efficient and most common for residential solar installations. These cells are a good choice where space is limited, and they can convert more solar energy into electricity than most other types of solar cells. However, monocrystalline cells tend to have a higher up-front cost.
- **Multicrystalline or polycrystalline solar cells** tend to be less expensive but require more surface area than monocrystalline cells to produce the same amount of energy (lower efficiency).
- **Amorphous thin film solar cells** are flexible, have a shorter usage life, and are used where space is not an issue and in areas where high temperatures and shade are anticipated. These cells are more resistant to damage from elements, such as hail or rocks. However, they are less efficient in normal sunlight but more efficient in low light conditions as compared to the monocrystalline.

Purpose of This Guide

Are you considering adding a solar photovoltaic (PV) energy system to your home to generate electricity? If so, this guide is designed to provide information and resources to help you make an informed decision, whether you choose a turnkey system, a do-it-yourself approach, or a combination of both. The information is presented in a series of steps that will help you reach a well-informed conclusion if you decide to pursue making an investment in your own solar energy system.

The Iowa Energy Center created this document in collaboration with Alliant Energy, the Iowa Association of Electric Cooperatives, the Iowa Association of Municipal Utilities, and MidAmerican Energy with information from the Office of Consumer Advocate and the Iowa Utilities Board.

The contact information for each contributor along with a glossary are included at the back of this guide. When making a decision about a solar energy system, consumers also should consider including their trusted advisors, such as accountants, attorneys, and tax professionals, in their research to provide additional expertise in the decision-making process. In addition, this publication can be used in tandem with other checklists and resources, such as the Iowa Utilities Board's Information Guide for On-Site Generation.

https://iub.iowa.gov/sites/default/files/files/misc/IUB_Informational_Guide_Distributed_Generation.pdf

Getting Started



Monocrystalline solar cells



Multicrystalline or polycrystalline solar cells



Amorphous thin film solar cells

DID YOU KNOW?



Off-grid or stand-alone systems are not connected to the utility grid but are typically connected to a battery bank that stores the energy for later use. Typically, these types of systems are located at remote sites where it is expensive to connect to the grid. In some situations, off-grid solar PV systems can be used as backup power in place of fuel-burning generators.

Solar arrays can be mounted to a building's roof or on the ground. Ground-mounted systems are typically near the building or point of consumption. With both roof-mounted and ground-mounted arrays, the system may be stationary, designed to have a fixed tilt, or have tracking capabilities to follow the sun as it moves across the sky.

Some solar generating systems include an energy storage component in which batteries are used to store energy produced during the day for use at night or other times of low production when the system isn't producing enough to meet the property owner's electricity needs. Battery storage also can be used to stabilize voltages and supply surge currents to electric loads and inverters.

Solar PV systems can be interconnected to the electric grid or can be operated as stand-alone (off-grid) systems. All grid-connected solar generating systems require an inverter, which safely and efficiently converts the direct current (DC) electricity generated by the solar array to alternating current (AC) electricity.

Most commonly, systems are connected to the utility electric lines and the solar energy produced replaces purchases from the interconnected utility, with any excess production being fed to the utility's electric grid. Data shows that consumers with typical solar generating systems need the grid to energize the solar generating system, to export the excess electricity or to import power from the grid to supplement solar production when the system is not generating enough to meet the consumer's needs. This is due to a mismatch between the timing of energy produced and energy usage.

Typical Iowa Residential Consumer with Onsite Solar System (Summer)

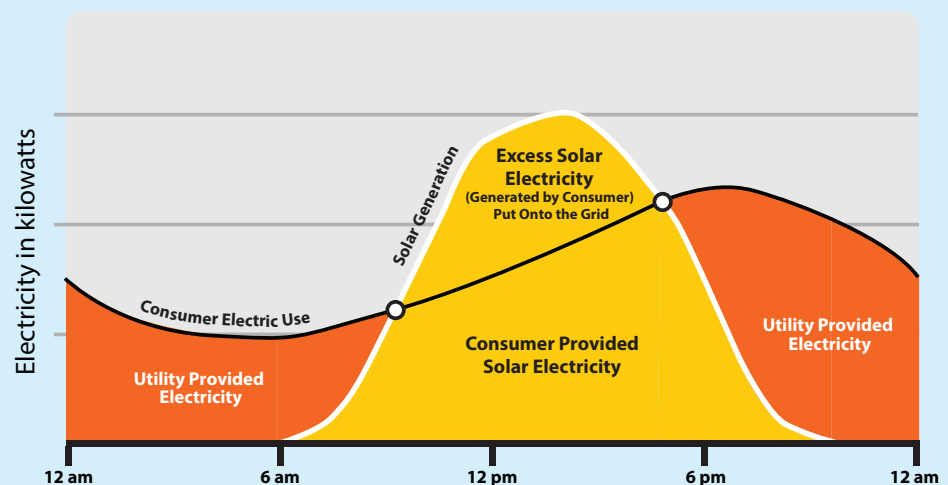

The technologies associated with the building blocks of a solar array project may seem complicated; however, the system design and construction are relatively simple and straightforward. There are no moving parts unless a sun tracking device is installed, and most of the electronics are self-contained and only require connection wires between components. Familiarity with the design and construction procedures is beneficial in becoming a more educated consumer and owner.

Setting Your Goals

Before designing a system or purchasing any materials, you should first identify why you are pursuing the installation of a solar array. Your goals for the project may impact several aspects of its design and construction. Some of the most common goals for constructing a PV array are:

- **Offsetting your personal electrical consumption.** By displacing a portion of the electrical power delivered by your local utility, you become less impacted by future rate changes and may be able to repay the initial capital investment with the avoided utility bill payments accumulated over the life of the project. Under this scenario, it's important to size the system to match your electrical needs without oversizing the system.
- **Managing future electrical costs.** If electricity costs are a substantial element of your monthly costs (e.g. livestock farming or in the commercial and manufacturing sectors), you may consider installing a solar energy system as a hedge against unknown future costs. By purchasing a solar energy system to supply a portion of your own electrical power needs you will incur an upfront cost; but you become somewhat immune to the unknown potential electrical rate escalations over the life of the system. You also may be in a better position to manage your costs knowing that a portion of your energy expense is fixed into the future.
- **Creating a new revenue stream.** You may want to install a solar energy system as a potential revenue source to supplement your income and offset your energy costs.
- **Going off the grid.** You may have a goal to sever your association with the utility serving your home or business. Designing your solar array will require prudent sizing with energy storage to provide electricity when the solar array is not generating power. Additionally, you will need to become an active manager of your energy consumption to balance your power needs with the capabilities of the solar array and energy storage device. Adding an energy storage device will significantly increase the cost of the solar system.
- **Being an environmental steward.** You may want to enhance your commitment to the environment by generating your electricity with a renewable energy source rather than relying on utility power that may be partially generated with fossil fuels.
- **Providing a backup power source.** You may have a need or desire to counter a blackout condition caused from a storm or other incident with your own source of power. A solar array alone cannot serve as a reliable backup power source as it sits idle when the sun is not shining and generates at reduced levels during cloudy and non-peak (early morning and night) periods. The addition of energy storage to your solar array may provide a limited backup source of power. Energy storage may be in the form of a battery bank, charged from the solar array and grid power; or a fossil-fueled (e.g. gas or diesel) portable generator.



DID YOU KNOW?

Many energy efficiency improvements will save energy, reduce utility bills, and help the environment for a much lower cost than installing a solar generation system. Because energy efficiency improvements reduce your electric usage, they also may contribute to reducing the size and cost of a solar array needed to meet your energy needs.

How to make energy efficiency work for you:

Complete an Audit:

- Contact your utility for a professional energy audit (home or business)
- Take advantage of online tips, information, and resources:
 - **Iowa Energy Center Home Series:**
iowaenergycenter.org/home-series
 - **Energy Star:**
energystar.gov
 - **U.S. Department of Energy, Office of Energy Efficiency and Renewable Energy:**
energy.gov/eere/efficiency/homes
- See Page 32 for a listing of the electric utilities in Iowa and visit your utility's website for online resources.

Preliminary Steps and Research

It is critical to do your homework and research throughout all phases of determining if an investment in a solar generating system is right for you.

Recommended Steps

1. **Maximize energy efficiency.** Completion of a thorough energy efficiency audit is an important precursor to considering a solar energy system. Implementing energy efficiency measures in advance of installing a solar energy system can save you money and reduce the size of the solar energy system you'll need to meet your energy needs.

EXAMPLE: To illustrate how energy efficiency can cost less than installing a solar array, consider an example of a consumer who uses incandescent lighting in their home. If the home has ten 60-watt incandescent bulbs that are used for 2.5 hours per day, the lighting consumption would be 548 kWh per year. LED lightbulbs are significantly more efficient than incandescent bulbs. There are LED bulbs that only use 9.5 watts, but produce the same amount of light as a 60-watt incandescent bulb. Purchasing ten LED bulbs would cost approximately \$53.50, and save 461 kWh per year compared to the incandescent bulbs. If you wanted to achieve the same savings through the installation of a solar array, you would need to install 340 watts of solar panels. As an example, if the cost is \$3.25 per watt, this would cost \$1,090. In other words, in this example it costs \$1,036 less to replace incandescent bulbs with LED bulbs than it does to install a solar array to achieve the same energy reduction.

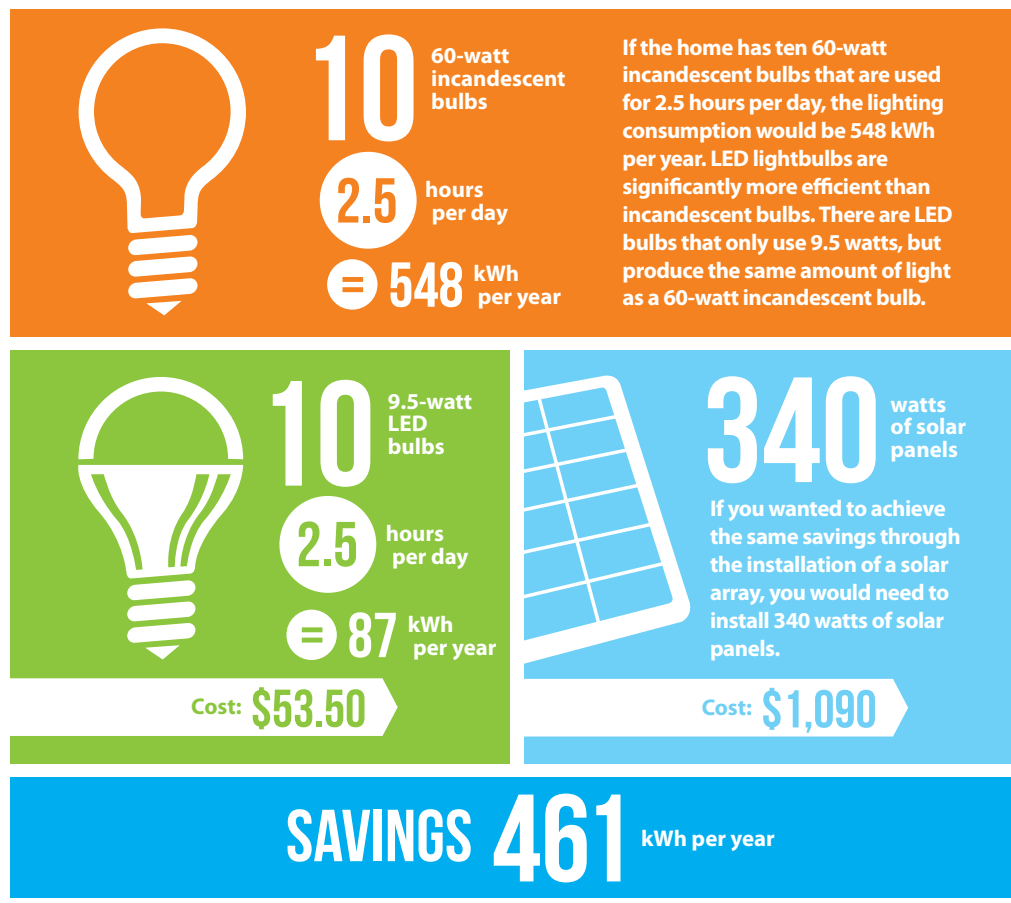

2. **Check with local authorities.** Plan a visit with your local authorities to learn the requirements for obtaining a building permit and to learn if there are any local ordinances that may either prevent the construction of a solar array or that limit its size, location, visibility, and setbacks. If your community has not addressed development of residential solar, you may experience delays while rules and requirements are developed. If you live in a platted development, you also should check any building restrictions and other requirements the covenants that may have been put in place by the developer of the plat. They can be found in the abstract to your property.
3. **Check with your local electric utility.** Schedule a personal visit with your electric utility. During your visit, obtain information that may affect the location, size and cost of the array; the value of the energy generated by the array; the safety issues that will need to be addressed; and any additional fees or costs that might be incurred with interconnection of a solar energy system. Iowa law (legis.iowa.gov/docs/code/476.pdf) requires that the owner must provide written notice to the utility no later than 30 days prior to the commencement of construction or installation of an alternate energy production facility, including a solar array. Iowa's utilities have an obligation to interconnect, and the Iowa Utilities Board has a streamlined process for interconnection of a solar energy system (see Pages 26-27 for more information).

In addition, learn about the following:

- a. What will your electric rate be after the array is connected to the grid, and will the array change your usage rate and monthly service charge?
- b. How will you be compensated for excess generation, and what is the buy-back rate for excess generation sold back to the utility? For example, if net metering is offered, learn if banking of excess generation is allowed and how often the account is settled (monthly, annually, never). If settlement dates are applied annually, identify which month is used and if there are choices related to the settlement month. If net metering is not offered, learn what the selling and purchasing rates will be for the net billing policy and if the points of settlement are monthly or annual. It's imperative to talk to your utility to understand how your load profile will work with your settlement month. Note: Iowa's rate-regulated utilities file information about their avoided cost with the Iowa Utilities Board. Non-rate-regulated utilities will provide information about their avoided cost upon request to your local utility.
- c. What effect will the solar energy system have on the current rates under which you are purchasing electric service from your electric utility and on any end-use rates that you may be receiving, such as electric heat rates, geothermal rates, and higher block rates?
- d. If you're on a demand or time-of-use rate, will your bill be impacted?
- e. If you have multiple meters or submeters, how many meters do you anticipate may be offset by a single solar array interconnection? Or, how multiple meters and submeters may be combined as a means to offset more loads and what are the electric rate implications for doing so?

DID YOU KNOW ?

Iowa law encourages the development of renewable energy sources. Iowa law does not allow gas or electric utility consumers to be subject to discriminatory, disadvantageous or prejudicial rates or terms for utility service based on a consumer's use or intended use of renewable energy resources.



- f. Does your utility offer a community-based solar opportunity or green pricing program? A community-based solar program may afford you the benefits of your own solar array without the ownership and maintenance responsibilities.
- g. Note that the information that you receive from your utility will represent current rates and tariffs. With the appropriate approval, rates, rate structures and tariffs may change over time to reflect changes in your utility's cost of providing service.

4. Understand your electric utility bill and your electricity usage patterns. Review one to two years of historical usage and cost records. The history will help you to understand how much and when you are using electricity. You also should talk to your utility to gain an understanding of the potential for future rate increases as this will affect the economics of your project.

If you are looking to reduce your peak/demand with a solar installation, you will want to make sure you understand the time and duration of your historical peak/demand and understand if the expected output of your solar energy system will adequately serve that purpose. Before purchasing a system, it is critical to speak with your utility to understand how solar energy generation will be applied to your bill. This will help you to develop a realistic estimate of potential savings from a solar energy system.

5. Prepare for a site assessment. After completing your initial research, a preliminary site assessment will help to determine the parameters and constraints that need to be considered during the design, bidding and construction phases.

▼ Understand Your Energy Bill and Rate Structure

Before investing in a solar energy system, it's critical that you talk to your utility and understand your rate structure. The rate structure that you're currently on may change once you install a solar energy system and should be factored into your calculations as it will impact your monthly bill. Below is a description of some of the charges that could be found on a utility bill.

FIXED CHARGE

The fixed part of the bill is often referred to as a service charge and is designed to cover the utility's cost to construct facilities and to connect your electric service.

ENERGY CHARGE

The variable components of the bill are those billed on an energy basis. These are designed to cover the costs associated with the actual monthly usage at your service location and appear as a per kilowatt-hour (kWh) charge. Some utilities also adjust the price of a kWh based on a seasonal rate or the time of day that kWhs are consumed.

DEMAND CHARGE

Some electric bills may include a demand charge, billed per kilowatt (kW). So, if your bill has a demand line item it is helpful to understand the difference between energy and demand. Energy is analogous to the odometer in your car. It tells you how far you've traveled, or on your electric bill, how much electricity you have used. If energy is the odometer, then demand is your speedometer. The speedometer tells you how fast you are traveling; similarly, demand tells you the rate in which you are using electricity at a particular point in time.

Conducting a Site Assessment

One of the most important decisions that you will encounter during the planning and construction of your solar array is determining the best location for the array. Will it be better situated as a roof-mounted system or in a more accessible ground-mounted location? There are several factors that may influence your decision.

Solar Array Orientation and Southern Exposure

In Iowa, the sun is visible in the southern sky. As such, a solar array should be oriented to the southern sky so that it is as nearly perpendicular to the sun's rays as possible. For a stationary array located in Iowa, orienting the solar array due south will provide the highest energy output. Arrays oriented east or west will have a 15-20% drop in performance while solar arrays oriented to the north will have an energy generation reduction of 30-45% as compared to an equally sized array that faces south. If your rate has a demand component that varies over time, you may need to consider whether something other than a due south orientation could be more beneficial by better aligning system production with periods of usage.

The site selection for the solar array should contain an unobstructed view of the southern sky. Buildings, trees or other obstructions that may cast a shadow on the solar array will reduce the potential of the system by the magnitude of hours under which the array is in a shadow. An instrument such as a Solar Pathfinder or Solmetric Suneye is useful in identifying sources of shadowing and is capable of predicting the annual hours in which the proposed site would endure a shadowed condition. An assessment is not completed until the effects of shadows on the proposed site have been determined. Every qualified solar contractor should use a solar shading instrument and its results in advising you of the best location for your array. See Pages 21-23 for additional information on selecting a qualified contractor.



▲ Panels impacted by tree shading.



▲ A Solar Pathfinder is an instrument that is useful in identifying sources of shading and predicting the annual hours a proposed site would endure a shadowed condition.

DID YOU KNOW ?

For a gabled roof on which the solar modules would be mounted parallel to and offset from the roof by a few inches, the measured roof area divided by the area of a single module (18-21ft²) will be useful to quickly determine the quantity of modules that can physically fit in the area and thus the potential capacity of the site. More specifically, the layout of the modules, either landscape or portrait, can be drafted using accurate roof measurements and module dimensions which can be estimated to be 66 x 40 inches to 78 x 40 inches.



▲ For central Iowa, the ideal winter tilt angle is about 58°, whereas in the summer a flatter tilt of about 18° is optimal. A ground-mounted system offers the flexibility to set the tilt to any desired angle. An entirely stationary array in Iowa will perform the best year round with a set tilt angle of 32°.

Available Area

The area available for either a roof- or ground-mounted solar array is often the primary driver in selecting the best location for a solar array. Capturing the sun's energy is primarily dependent on the area of solar cells exposed to the sun's rays. Obtaining the energy required from the sun to meet your project goal is directly related to the quantity of solar modules required and the area that they will consume when installed. The unobstructed southern facing roof or ground area is a physical constraint that will dictate the site's potential for even the most efficient solar modules.

Tilt Angle

Identifying the range of tilt angles (the module angle from horizontal) available from a proposed site is essential in determining the potential generation of a solar array.

Since the sun's angle changes daily east to west and seasonally north to south, it is impossible to design an array that can reach its full potential unless a dual axis tracking device is incorporated into the design, which can improve the performance of an array by as much as 20-25%. Single axis tracking devices are available that can improve the performance of an array by as much as 12%. Mechanized tracking devices are typically applied only to ground-mounted arrays and the cost associated with any mechanized tracking device will determine whether it is an economically sound investment.

The tilt angle of a typical gabled roof-mounted array will normally take on the same angle as the pitch of the roof. A 4/12 pitched roof will have a tilt angle of 18.4° while a roof with a pitch of 6/12 will have a tilt angle of 26.6°. The ideal pitch angle will vary by season and the location latitude.

If time of year or seasonal electric rates differ substantially, this is an important consideration in calculating the return on investment. Therefore, incorporating a tilt angle that coincides closer to the seasonal sun angle is an important consideration.

Manually operated single axis tracking rack designs are commercially available and permit the tilt angle to be adjusted manually. By manually resetting the tilt angle as the seasons change, an 8-12% improvement in solar array performance can be realized. The initial cost for the additional mechanism and the labor cost associated with resetting the angles need to be accounted for when determining the return on investment.



▲ This solar array has a mechanized tracking device incorporated into its design.



DID YOU KNOW ?

Optimally, the energy output of a solar array is maximized if the angle of the solar module is perpendicular to the sun.

Roof-Mounted Considerations

When considering a roof-mounted system, the condition of the roof should be closely examined by a roofing professional for structural deficiencies, remaining life, and existing or the potential for leaks. Repairs and corrective measures must be completed prior to the solar array construction. The structural integrity of the roofing system should be examined by a qualified professional to determine whether the roof structure can carry the additional dead load that the solar array will impose. Unintended uplift forces, caused by high winds, can be imposed on the roof especially where the array is installed nonparallel to the roof. Roof and array racking fasteners need to be designed for the tensional forces that will be imposed when uplift forces are experienced. This phenomenon is particularly acute on flat roof installations where roof penetration anchors are utilized instead of using a ballasted anchor system. Regardless of the final design, any roof penetrations need to be performed with care and properly sealed to prevent premature wear and potential leaks.



Solar cells can reach high temperatures, which negatively impacts system performance, due to ambient conditions, reflected/radiated/convected heat from the roof. Partial shading of a cell/module also can have a negative performance impact by creating a phenomenon termed reverse bias. With reverse bias, the cell draws current from adjacent cells creating a “hot cell,” which reduces the net current supplied by the module. Chimneys, dormers, other rooftop protrusions, trees, or utility poles can cause partial shading. In wet or high dew conditions, leaves can adhere to the solar module and cause reverse bias. Even bird droppings on a solar module can lead to shading and reverse bias issues. In rural areas, airborne dust

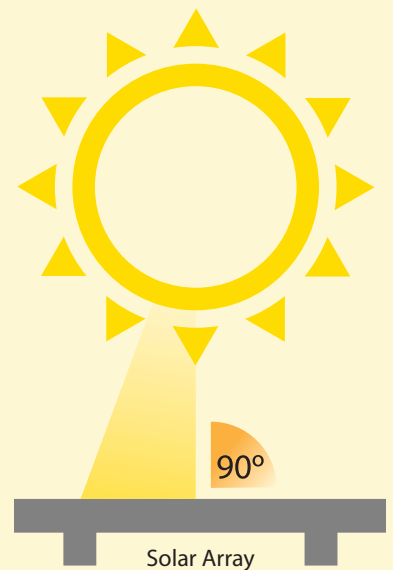

Solar Array

DID YOU KNOW ?

The performance of a solar array degrades as the temperature of the solar cell increases.

from roadways, animal operations, crop planting, or harvesting operations can settle on modules, especially wetted surfaces. (Note: See Page 14 for examples of shading caused by dust and bird droppings.) If dust collects at one end or corner of the module, the partial shading also can cause reverse bias. As such, adequate ventilation is desired around the solar modules to keep the surface temperatures moderate, and partially shaded modules should be avoided.

Ground-Mounted Considerations

Ground-mounted solar arrays present issues that require consideration during the site assessment phase. Aside from the area requirements and shading implications, ground-mounted systems require an examination of the soil conditions in which footings for the array racking system will be set. The analysis is performed to determine the soil type and bearing capacity, the water table level, and the location/depth of bedrock that may influence the type of footing that should be chosen. Zinc-plated, galvanized steel piles and concrete piers are the most common footing designs for PV arrays. The size and depth of the footings are dependent on the type of racking system that is chosen and the loads that will be borne by the soil. As the foundation of the entire system, a qualified geotechnical professional should perform the soil analysis and foundation design.

With a ground-mount solar array, maintaining vegetated areas beneath the solar array may be a difficult chore for certain framed racking system designs and less so for certain cantilever designs. Placement of gravel or another non-plant material beneath the array may alleviate this concern.



Flat roofs and ground-mount systems offer slightly more flexibility in the orientation and layout of the solar array. In these situations, multiple rows of single or stacked modules can be used to accommodate the area while meeting the desired energy generation goals. Consideration for any elevation deviations and the distance between adjacent rows are necessary to ensure that a southern row will not cast a shadow on the adjacent row to its north. Basic geometry and the knowledge of the sun's angle at its lowest point permit a calculation for determining the minimum row spacing that will avoid shadowing.

Designing the Solar PV Array

After completing the research and site assessment phases, you can begin to formulate a solar array design that will meet your intended goals and conform to any of the site constraints that may exist. While you may be interested in completing the design phase on your own, you'll likely need to rely on the expertise of a contractor that specializes in solar array site assessment, design, and construction. Having the basic knowledge of the system design will help you converse with the potential contractor(s), ask substantive questions, and be better prepared to decipher whether the answers are technically credible, or strictly sales based. While this section will not make you an expert in PV design, it is intended to provide you with a foundation of knowledge necessary to go into the project as an informed consumer.

Sizing the System

STEP 1: Calculate your energy (kWh) needs by obtaining the energy usage requirements from your historic electric bills. Averaging the most recent two or three consecutive years of energy usage will define your needs more accurately than using just the past year, because weather-related peaks will be smoothed. In addition, make any adjustments for recent energy efficiency improvements that have been or will be made at the property. Data representing periods of energy usage that no longer exists should be discounted or adjusted to account for the changes (e.g. additions or expansion of home/business; installation or removal of electric heating/cooling systems including ground source heat pumps; addition or reduction of the number of dwelling occupants;

DID YOU KNOW ?

The number of daily hours in a month or year that is equivalent to the full sun intensity is referred to as the solar radiation. The Department of Energy's National Renewable Energy Laboratory (NREL) has compiled the solar radiation for sites across the U.S. on both a monthly and annual basis for different tilt angles. For example, the annual radiation in Des Moines, Iowa at a tilt angle equal to its latitude (about 42°) is 4.8 hours – meaning that a 1 kW solar array could generate 4.8 kWh/day or expressed annually as 365 days x 4.8 kWh/day = 1,752 kWh/year assuming no system losses.

Optimum Tilt Angle – Des Moines, IA (vertical/horizontal)

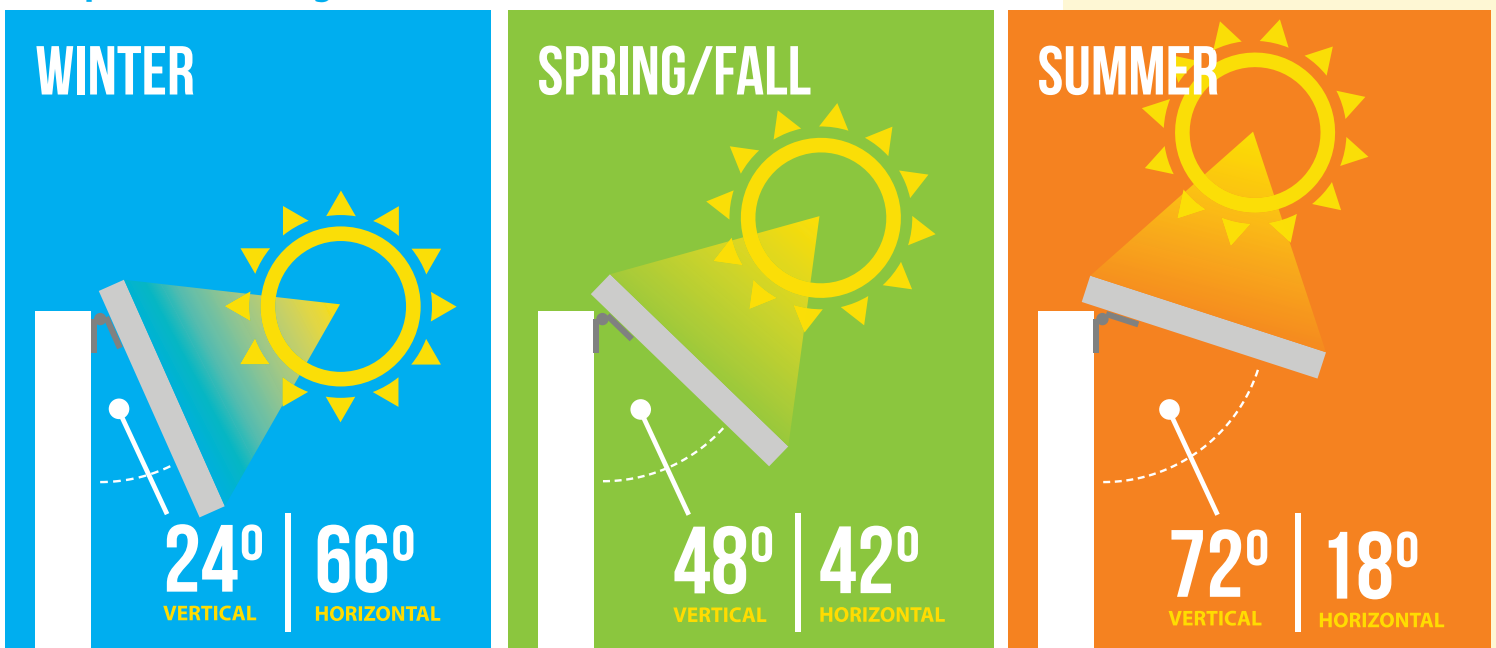

Angles(V/H)											
Jan	Feb	Mar	Apr	May	Jun	Jul	Aug	Sep	Oct	Nov	Dec
32°/58°	40°/50°	48°/42°	56°/34°	64°/26°	72°/18°	64°/26°	56°/34°	48°/42°	40°/50°	32°/58°	24°/66°



▲ An experienced site assessor can calculate a more precise estimation, although the typical losses will provide a very good design level. Particularly dirty locations where soiling is expected to be above average and regular cleanings are not forthcoming should be accounted for by adjusting the loss factor proportionally higher.

▶ These panels show soiling from dust, debris and bird droppings.

partial year occupancy). If you will be interconnected to your servicing utility, and they offer a net metering with banking policy the average annual usage calculation is sufficient. If the policy does not include net metering with banking – such as a utility payment for any excess generation or a net metering without banking policy – more frequent interval information would be important (e.g., monthly rather than annual usage data).

STEP 2: Match the solar resource to your energy usage requirements. In Iowa, the solar irradiance – often referred to as the solar intensity – on a cloudless summer day is approximately 1,000 watts per square meter. This intensity level also is the international standard by which all solar modules are rated. For example, a 300-watt rated solar module will produce 300 watts of power when 1,000 watts per square meter of light intensity hits the solar module surface at the standard temperature of 77° F (solar module efficiency will fall as the temperature increases above 77° F). The module will produce more energy when the solar intensity rises above the standard level and produce less when lower levels of solar intensity are experienced. The actual level of solar intensity is dependent on the sun's position and the angle of the receiving solar module relative to the sun. The highest absorption of the sun's energy occurs when the receiving surface is perpendicular to the sun. As the angle to the sun deviates from perpendicular more light is reflected off the solar module rather than being absorbed, resulting in lower module performance.

STEP 3: Anticipate system losses from reduced solar output. System losses of the solar energy system can be estimated to determine an appropriate system derate/loss factor. The system losses are the combination of many sources, including soiling, shading, inverter efficiency, snow, mismatched modules, wiring, connections, light-induced cell degradation, nameplate rating tolerance, and age. Typical system losses of 15-20% should be used when sizing the system. An experienced site assessor can calculate a more precise estimation, although the typical losses will provide a very good design level. Particularly dirty locations where soiling is expected to be above average and regular cleanings are not forthcoming should be accounted for by adjusting the loss factor proportionally higher. More information regarding the system loss components can be found at rredc.nrel.gov/solar/calculators/PVWATTS/change.html#derate.



The following example illustrates a simplified PV sizing design for a site where net metering with banking is applicable:

EXAMPLE 1: SITE ASSESSMENT AND SIZING STEPS

Site Assessment Data:

- Location: Des Moines, Iowa
- Averaged full energy usage requirement goal after implementing energy efficiency measures = 900 kWh/month or 10,800 kWh/yr.
- Roof-mounted array with southern exposure, no shading and a roof pitch of 6/12 (26.5°) having total roof size of 45 ft. long x 16 ft. wide and a usable roof area = 42 ft. long x 13 ft. wide = 546 ft² (assume 3 ft. peak edge and 1.5 ft. side edges for National Fire Protection Code compliance)
- Assumed system losses = 15%
- Assume 72-cell solar modules having nominal area of 21 ft² and dimensions of 39"x78"

Sizing Steps:

1. Look up the appropriate solar radiation for the location at a tilt angle equal to the latitude less 15° ($42^\circ - 15^\circ = 27^\circ$) = 4.8 kWhr/kW/day
2. Calculate the size of the solar array $(10,800 \text{ kWh/yr.}) / [(4.8 \text{ kWh/kW/day})(365 \text{ day/yr.})(0.85 \text{ losses})] = 7.25 \text{ kW}$
3. Calculate the minimum solar module rating $(7.25 \text{ kW})(21 \text{ ft}^2/\text{module}) / (546 \text{ ft}^2) = 0.279 \text{ kW/module}$
4. Choose a commercially available solar module = 300 watts
5. Calculate the quantity of modules required = $(7.25 \text{ kW}) / (0.300 \text{ kW/module}) = 24.1 \text{ modules}$
 - a. Lay out the modules – try two rows of 12 modules arranged in portrait
 - b. Array length = $(12 \text{ modules})(39 \text{ inches})(1 \text{ ft./12 inches}) = 39 \text{ ft.}$
 - c. Array width = $(2 \text{ modules})(78 \text{ inches})(1 \text{ ft./12 inches}) = 13 \text{ ft.}$

Sizing a PV solar array for a situation where any of the following may occur could result in a much different design from the situation described in Example 1: 1) payments are received for excess energy generation (based on the utility's avoided cost rate) instead of being banked; 2) a net metering policy requiring monthly settlements is offered; or 3) electric heat rates are used. The simple analysis used in Example 1 is based on annual consumption and generation numbers, must be replaced with a more detailed monthly analysis using the applicable purchasing and selling values of energy. Generally, the most cost-effective array size for that situation will be smaller in array size, by as much as 30-40% in extreme cases, since the solar resource in Iowa during the winter months is only about 60% of the summer months.



DID YOU KNOW ?

When it comes to solar energy, bigger isn't always better. Oversizing a solar array can have a negative financial affect. Overproducing under a net metering with indefinite energy banking policy can lead to large energy credit balances that if not consumed provide no financial benefit. Similarly, significant energy overproduction can diminish the return on investment for cases where a net metering with annual settlement policy is used and the excess energy is purchased at the utility's avoided cost. If a system is sized conservatively (smaller), it can incrementally be added to if conditions warrant it in the future.

Software-Based Calculators

There are several software-based calculators that can quickly aid in sizing a solar PV array. NREL offers two online calculators – PVWatts and System Advisor Model (SAM) and the Iowa Energy Center provides an Iowa-based resource. All of the calculators provide comparable results for similar input assumptions.

PVWatts uses a trial and error process to narrow the rating of the array to match your desired annual energy output. Care must be exercised in choosing realistic system loss factors as defined by the integral derate factor subcalculator. PVWatts also offers a simplified financial calculator providing the benefit of the solar array based on an assumed fixed value of energy.

pvwatts.nrel.gov

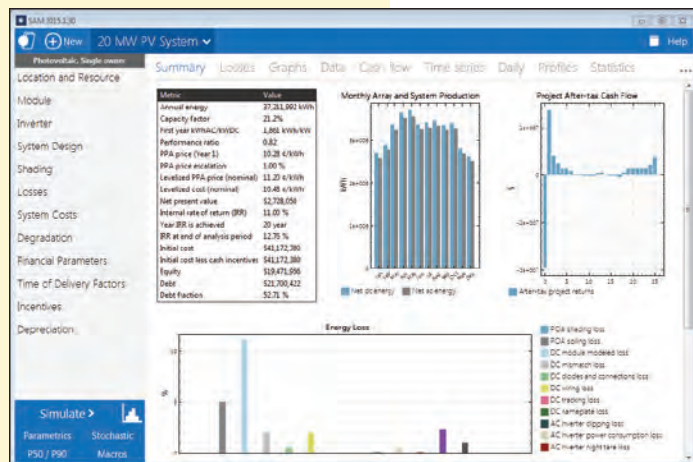

SAM is a downloadable calculator application, which is used as a stand-alone tool. The SAM calculator offers greater flexibility and level of input detail and includes a substantial financial modelling aspect.

sam.nrel.gov

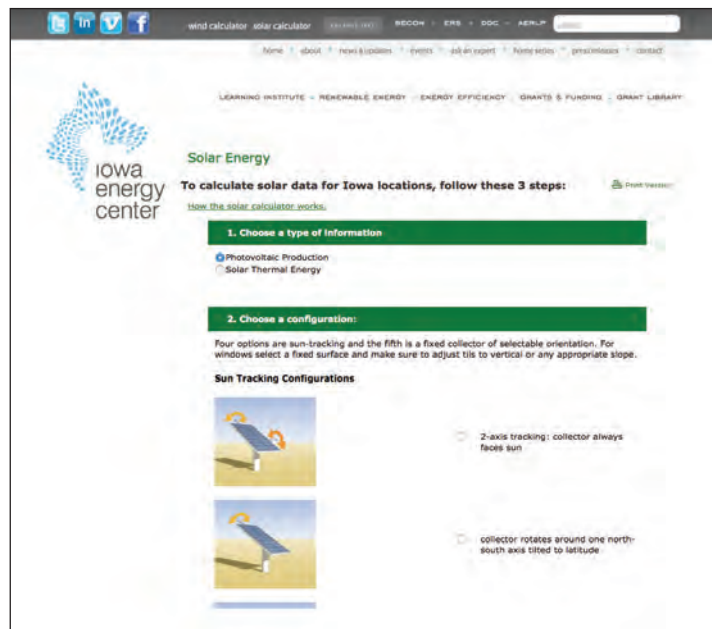

The **Iowa Energy Center's Solar Calculator** provides the solar resource potential for any location in Iowa but does not have a provision for incorporating the system losses. System losses must be applied externally from the calculator. The calculator does not contain a financial modelling component.

iowaenergycenter.org/solar-calculator-tool

Example 2 (below) assumes the same conditions described in the previous example but replaces the net metering with banking policy with a net metering with monthly settlements policy (without banking). Additionally, it assumes the household uses electricity for their winter space heating, for which they receive a lower electric rate, which the customer will not be eligible for after the construction of a solar energy array.

EXAMPLE 2: SITE ASSESSMENT AND SIZING STEPS

Site Assessment Data*:

- Location: Des Moines, Iowa
- Averaged full usage requirement goal = 900 kWh/month or 10,800 kWh/yr.
 - 4,900 kWh @ electric heat rate; 5,900 kWh @ regular house rate
- Electric heat rate = \$0.05/kWh
- Regular house rate = \$0.12/kWh
- Electric utility avoided cost purchase price for excess energy generation = \$0.04/kWh
- Initial solar energy array construction cost = \$3,000**/installed kW-DC

**Government incentives are not included in this example.

Sizing Steps:

1. Calculate the total electric costs before the solar energy installation disregarding fixed costs like the standard meter charge = $(4,900 \text{ kWh} * \$0.05) + (5,900 * \$0.12) = \$953.00/\text{yr}$.
2. Using one of the solar resource assessment tools, determine the monthly generation of the solar array sized (7.25 kW in this example)
3. Calculate the new monthly cost or credit after the solar array is installed. (See table below)
 - a. January: $(1,400 \text{ kWh consumed} - 685 \text{ kWh solar generated}) * \$0.12/\text{kWh} = \$85.80 \text{ cost}$
 - b. April: $(1,005 \text{ kWh solar generated} - 800 \text{ kWh consumed}) * \$0.04/\text{kWh} = \$8.20 \text{ credit}$
4. Calculate the annual utility bill savings: $\$953.00 - 201.76 = \751.24
5. Calculate the simple payback period (initial cost divided by the annual benefit): $(7.25 \text{ kW} * \$3,000/\text{kW}) / \$751.24/\text{yr} = 28.95 \text{ yr}$.
6. By trial and error, choose different array sizes and repeat steps 1-5 to find the solar array size that minimizes the simple payback period
 - a. 9 kW – 29.35 yr.
 - b. 6 kW – 28.68 yr.
 - c. 5.8 kW – 28.63 yr.
 - d. 5.6 kW – 28.67 yr.
7. Choose a 5.8 kW solar energy array (20% smaller than in the 7.25 kW determined in the first example)
8. Choose a commercially available solar module = 290 watts
9. Calculate the quantity of modules required = $(5.8 \text{ kW}) / (0.290 \text{ kW/module}) = 20 \text{ modules}$
 - a. Lay out the modules in two rows of ten modules arranged in portrait
 - b. Array length = $(10 \text{ modules})(39 \text{ inches})(1 \text{ ft.}/12 \text{ inches}) = 32.5 \text{ ft}$.
 - c. Array width = $(2 \text{ modules})(78 \text{ inches})(1 \text{ ft.}/12 \text{ inches}) = 13 \text{ ft}$.

*Your data may vary depending on your situation.



This table depicts the month-by-month cost analysis and utility bill savings for Example 2, which is provided on Page 17.



Utility Bill Savings for a 7.25 kW-DC Solar Energy Array

Month	Electric Heat Load (kWh)	House Load (kWh)	Pre-Solar Cost	Solar Array Generation (kWh)	Post-Solar Cost/Credit
January	1,000	400	\$98.00	685	\$85.80
February	900	400	\$93.00	788	\$61.44
March	700	400	\$83.00	937	\$19.56
April	400	400	\$68.00	1,005	-\$8.20
May	200	400	\$58.00	1,098	-\$19.92
June	0	600	\$72.00	1,128	-\$21.12
July	0	800	\$96.00	1,181	-\$15.24
August	0	800	\$96.00	1,059	-\$10.36
September	0	500	\$60.00	923	-\$16.92
October	200	400	\$58.00	828	-\$9.12
November	600	400	\$78.00	593	\$48.84
December	900	400	\$93.00	575	\$87.00
Total	4,900	5,900	\$953.00	10,800	\$201.76

$$\text{Pre-Solar Cost } \$953.00 - \text{Post-Solar Cost } \$201.76 = \text{Annual Utility Bill Savings } \$751.24$$

Equipment Selection

Taking some time to learn about the significant components of a solar array (modules, inverters, and racking system) will be helpful as you work with your contractor.



Solar Modules

All legitimate solar modules are designed and manufactured to a set of international standards that ensure the performance of the solar module and the manufacturing quality. At a minimum, the modules should be certified to meet the appropriate standards developed by the International Electrotechnical Commission (IEC,) including IEC 61853 and IEC 61215, which addresses the performance testing of the module. The module also should be certified by the Underwriters Laboratories (UL) Standard 1703, which addresses the fire safety aspects of roof-mounted solar arrays. These standards protect the consumer by placing all modules on an even playing field. This means that a solar module from one manufacturer having a rating of 300 watts is comparable to a solar module from a different manufacturer with the same rating. As such, the consumer can make a purchasing decision based primarily on price. Differences in warranties or origin of the manufacturer may be considerations that sway the final choice when prices are comparable.

Inverters

Similar to solar modules, grid-tied inverters are manufactured to exacting standards. The primary standards for grid-tied inverters are the Institute of Electrical and Electronics Engineers Standard 1547 and Underwriters Laboratories Standard 1741. Unlike the solar module industry, there are two distinctly different inverter products used in the PV industry; string inverters and micro-inverters. Either technology can offer exceptional performance when best practices have been incorporated into the overall system design.

String inverters combine the capacity of multiple solar modules by “stringing” the modules together electrically prior to inverting the DC module power to AC grid power. The micro inverter technology pairs a single inverter to a single or paired set of solar modules and is generally mounted on the back side of the module. Both technologies have their advantages and disadvantages; however, the most important consideration is how closely the inverter rating matches the power output of the connected solar modules. When the DC rating of the solar module(s) is greater than the rated input power of the inverter, the excess DC power is “clipped” or wasted in the form of heat. Conversely, inverters that are rated significantly higher than the total DC rating of the solar module(s) will operate at a lower efficiency.

For example, a 300-watt rated solar module connected to a micro-inverter having a maximum DC input rating of 250 watts will clip the energy delivered by the module in excess of 250 watts. A 3-kW string inverter connected to a series of ten 300-watt solar modules will perform at a low efficiency during the early morning and late evening hours when the solar intensity is substantially lower than midday. When using an underrated inverter in one of the solar PV calculators, the rating of the inverter should generally be used instead of the module ratings.

Several leading string inverter manufacturers have Web-based design aid calculators that allow specific solar module model numbers as an input for which the calculator provides the quantity of modules that can be safely connected to it and a series of wiring configurations with corresponding power levels that can be used.



▲ A set of string inverters



▲ A micro inverter

Racking Systems

The materials and design of the racking system incorporated to support the solar array are a crucial part of the solar array. Both roof- and ground-mounted pre-engineered racking systems are available on the market and are widely used.

Ground-mounted racking systems can be constructed of pressure treated timbers, lightweight corrosion-resistant coated metal or aluminum. Both framed and cantilevered designs are common and equally effective in supporting the array when designed in accordance with good engineering practices. Framed racks may inhibit your ability to maintain vegetation beneath the structure more than a cantilevered design. The area beneath the array can be covered with gravel to reduce



▲ Adequate clearance between the ground and lower edge of the array is necessary to allow melted snow to easily slide off and not pile up on the lower edge. These photos show inadequate clearance and snow piled up on the lower edge, ten days after a snowstorm.

maintenance concerns. Adequate clearance between the ground and the lower edge of the array is necessary to allow melted snow to easily slide off and not pile up on the lower edge. Ground-mounted racking systems are anchored into the ground with footings that are sized based on the loads imposed by the array and the bearing strength of the soil. Footings should always extend above the surrounding ground and safely beneath the frost depth at the location. A geological boring and soil sample should be completed to determine the soil properties and water table level.

Roof-mounted racking systems should be constructed of lightweight corrosion-resistant coated metal or aluminum and carry a UL2703 certification. The roof-mounted system can be anchored to the roof, typical for inclined roofs, or can be anchored or ballasted for flat roof installations. Typical roof-mounted PV arrays can add approximately 3-6 lb./ft² of dead load to the roof. Particular attention should be given to the roof penetration details associated with an anchored design to avoid future leak problems. The roof's structural members and its fasteners should be evaluated by a professional to assess the roof's ability to withstand any uplift forces that may be induced by the wind as a result of the solar array. Arrays tilted beyond the roof pitch are particularly vulnerable to uplift loads. The additional weight associated with a ballasted system will vary with the array size and needs to be accounted for when checking against the roof's load capacity. In Iowa, the racking design should account for snow accumulation and have enough clearance at the bottom edge to permit melted snow to easily slide clear of the modules and not pile up on the lower edge that will cause shading and ultimately poorer performance.

Racking systems for both roof- and ground-mounted arrays may be designed to allow manual adjustments of the array tilt angle. An energy generation increase of 8-12% might be realized by being diligent in making the adjustments as the seasons change. Mechanized single or dual axis solar trackers can also be considered. Dual axis trackers are generally mechanized structures that may generate an additional 20-25% energy generation annually. The feasibility of a tracker device is an economical decision based on the comparison value of the additional energy generated against the additional upfront cost.



▲ A battery bank

Energy Storage

Battery banks are the most common type of energy storage device connected to PV solar arrays. When charged, the energy stored in a battery may be used during periods when the solar array is not generating energy (e.g., night, cloudy days, power interruptions). The motive for installing a battery bank needs to be carefully understood as it may add considerable cost to the system. While a PV solar array connected to a battery bank may be an ideal solution for a remote

site where the cost of bringing in grid power is prohibitive, such as a lake cabin, battery banks are generally not considered as an ideal backup power supply since they have a limited energy capacity and cannot be rapidly recharged by the solar array. Proceeding with your own independent energy storage bank requires that the size of the battery bank be balanced against the critical loads that it will be expected to serve and that diligent energy management of those same loads when the battery bank is enlisted is necessary to ensure that the energy capacity of the battery bank is not fully exhausted. Contact your electric utility if you are adding storage to an already installed system or have plans to do so in the future. It's worth noting that energy storage technologies are constantly evolving.

Monitoring System

Regular monitoring of the PV array for performance is a primary operational requirement. Software packages are available that monitor real-time performance and maintain a historical record. The monitoring system is generally interfaced through the inverter and accessed through a computer.

Micro-inverter monitoring technology is capable of monitoring each solar module individually since they are paired individually, which quickens troubleshooting problems. Partially shaded, soiled, or damaged modules can be quickly isolated and corrected. String inverters can only monitor the string of connected modules as a group. In the event of a problem, trial and error testing of individual modules is required. Single module problems can be difficult to notice as the underperformance of an individual module may be masked by the string as a whole.

Selecting a Contractor

Selecting a contractor to install your solar array is a critical aspect of your project. The selection should be made after evaluating credentials, work experience, business-related references, business integrity, and pricing. Multiple contractors should be interviewed, and written proposals/quotes for turnkey services should be obtained. A thorough due diligence assessment/evaluation of the contractor must be similar to the type of assessment you would conduct on home builders and home improvement contractors who perform significant work on your home or property. Your assessment should also include the company's rating with the Better Business Bureau and any pertinent reviews.



 A battery bank

Evaluating Bids

Evaluating a proposal for the construction of a solar PV array may seem complicated but can be simplified by utilizing a few standard metrics. The metrics permit you to quickly compare the merits of multiple bids where the array ratings may be different. The installed cost metric is calculated by dividing the turnkey contract price by the DC rating of the array.

TURNKEY COST 
 ÷ **INSTALLED KW-DC**

All other aspects being equal, the lowest installed cost metric is the most economical. This metric works since the DC performance ratings of solar modules are standardized. More importantly, the cost of energy metric, derived by dividing the turnkey contract price by the product of the annual energy generation and the expected life of the array ($\$/\text{kWhr}\cdot\text{yr.}/\text{yr.}$), provides the levelized energy unit cost that can be compared against the cost paid to your electric utility.

The cost of energy metric should be scrutinized to ensure that the annual energy generation and array life expectations are reasonable and not exaggerated. Small array performance improvements can be achieved by minimizing the system losses although it is necessary to understand that optimizing losses year-round may not be possible (e.g., assuming that soiling losses will be minimized year round may not be realistic at a rural setting on a gravel road). Include a requirement that each bid contains the worksheet used to calculate the annual energy generation with all of the assumptions used to calculate the system losses.



Credentials

Contractors specializing in the PV solar site assessment, design, and construction services should have adequate credentials that demonstrate completion of a minimum level of training.

The North American Board of Certified Energy Practitioners (NABCEP) offers entry level knowledge assessment, professional certification, and company accreditation programs to renewable energy professionals throughout North America. Contractors who have earned the NABCEP certification have passed a rigorous exam and have demonstrated a high level of training and experience. The NABCEP PV Installation

Professional Certification has been accredited to the ISO/IEC 17024 standard by the American National Standards Institute. NABCEP certified professionals can be located with complete contact information from their website at nabcep.org.

The Midwest Renewable Energy Association (MREA) offers a certification program that provides proof of completion of the educational competences and skills needed to conduct high-quality site assessments to future clients and employers. The certificate verifies MREA site assessment course completion including satisfactory completion of the MREA training course, two practice assessments and a site assessment exam.

Other credentials that may be required or desirable include an Iowa electrical license and Iowa Professional Engineer or the ability to hire one. The contractor should also have the minimum “tools of the trade,” including a solar shading instrument as described on Page 9.

Work Experience

The contractor’s work experience should be relevant to the type (roof- or ground-mounted) and size of PV solar array that is being proposed. References provided by the contractor should be checked to validate their work experience. Determine the reference consumer’s level of satisfaction with the contractor’s site assessment, design, and construction phases. Learn whether the promised array performance was met and if any problems occurred after the commissioning. If possible, make site visits to the contractor’s references to evaluate the quality of work.

DID YOU KNOW?



All Iowans are required by law to notify the Iowa One Call System at least 48 hours (excluding Saturdays, Sundays and legal holidays) prior to engaging in any type of digging or excavating. Homeowners and private residents are not exempt from making this important notification.





Questions to Ask a Qualified Contractor or a Solar Vendor

- What is the total installed (turnkey) cost of the system?
- How much money is due upfront, and what is the schedule of payments?
- If my energy usage changes, will I be able to add more panels later?
- Do I need a new roof now in order to install? Is my roof suitable to carry the additional live, dead and uplift load forces that the solar array will exert?
- When was your company established and how much solar has it installed to date? Can your company provide a list of the projects and references for them?
- Is your company affiliated with other parties to deliver the installation and who are they?
- Does your company have a Standard Insurance Certificate with adequate General Liability coverage of \$1 million or more? (Ask for a copy and keep it with your records.)
- Does your company have Professional Liability Insurance? (Ask for a copy and keep it with your records.)
- Does your company carry Workers Compensation? (Ask for a copy and keep it with your records.)
- Do you have the ability to cover me as an "Additional Insured"?
- Are your solar installers North American Board of Certified Energy Practitioners (NABCEP) Solar Photovoltaic (PV) Electric trained and certified?
- Do you have a licensed Iowa Professional Engineer on staff to review and approve drawings for submission to city/county building code and fire department officials?
- Are you accredited with the Better Business Bureau? If so, what is your rating?
- In which country are the solar panels and inverters you are selling made?
- Will the company honor your manufacturer's multiyear performance warranty?
- Does the company have a Master Electrician on staff to obtain the required electrical permits and to supervise the electrical work for your project? (Ask for a copy and keep it with your records.)
- Is your solar installer company a Licensed Electrical Contractor which is required to install Solar Electric Systems? May I see your company's license?
- Who will be working on my roof, and how much experience do they personally have installing solar?
- How does your company handle projects during busy times? Do you work with sub-contractors?
- How long will the installation take?
- Will the age or type of my roof affect the cost of installation?
- How will installation affect my roof? Will it create leaks? What if it does create leaks, are you then responsible for repairs?
- If I'm planning on re-doing my roof, should I install panels before or after?
- How much of my energy usage would my solar system cover?
- How much would my monthly energy bills be after installation? From you and from my utility?
- How long will my payback period be on my solar system? What are the key assumptions associated with my payback that may impact that result? (Ask for a copy of the calculations and keep the data with your records.)
- How will solar affect my homeowner's insurance?
- Will you complete all of the paperwork associated with getting the permits and financing?

Calculating the System ROI

DID YOU KNOW ?

Electric utilities are generally required to: (1) interconnect with renewable energy generation facilities and transmit renewable energy to another electric utility on reasonable and non-discriminatory terms and conditions; (2) sell to renewable energy generation facilities on terms that are reasonable and non-discriminatory; and (3) purchase from renewable energy generation on terms that are consistent with the utility's avoided cost.

Avoided cost and interconnection topics are addressed more comprehensively in The PURPA Title II Compliance Manual, co-sponsored by the National Association of Regulatory Utility Commissioners, the National Rural Electric Cooperative Association, the American Public Power Association, and the Edison Electric Institute. See publicpower.org/files/PDFs/PURPA%20Title%20II%20Manual%20Final_w-cover.pdf.



There are several ways to determine if an investment in a solar energy system makes financial sense for you. Two of the most common are estimating a return on investment and determining the payback period for an investment. A return on investment is estimated by dividing the value of the net savings from an investment by the costs of the investment. Usually, the estimate is made over the expected life of the investment, factoring in the time value of money. A payback period is calculated

when there is a large upfront cost for an investment and estimates at what point in time, if any, the net savings received will outweigh the initial cost.

To estimate the return on your potential solar investment, you will need to pull together all the estimated savings and costs of the project and consider the time-value of those savings and costs over the life of the investment. The cost portion of the analysis will be somewhat different if you purchase solar panels rather than leasing them. Talk with your electric utility so that you understand the following items, as applicable, and how they will impact your investment:

- Avoided Cost Credit
- Net Metering
- Demand Charge
- Fixed Monthly Service Charge
- Flat Energy Charge
- Blocked Energy Charge
- Escalation of Savings
- Degradation of Solar Production

Solar Energy System Purchase. If you are purchasing your solar panel(s), inverter, mounting hardware and accessories you will have a substantial upfront cost. There may be federal or state tax credits or other incentives*, grants or low-interest loans, available to you to help reduce this initial cost. *Refer to the following section on incentives.

Solar Panel Lease. If you are leasing your solar panel(s), inverter, mounting hardware and accessories, you will likely have small, if any, upfront costs, but will instead pay for the investment over time. It will be important to know what is covered in your lease agreement, so you will be able to accurately determine what additional costs you may incur.

Interconnection and Electric Service Upgrades. Two important questions need to be asked prior to purchasing a solar generation system:

1. Will the installation require me to upgrade my existing electric service?
2. Will the installation require my local electric utility to upgrade their facilities?

In many cases, upgrades will not be required because the solar generation will simply offset your current electricity needs, and there is capacity available in the electric panel.

In some cases, it is possible for the solar generation to require that your electric utility upgrade or change your electric service or the local electric distribution grid. To find out whether this will be required of your project, contact your electric utility very early in your project investigation.

In most instances, the costs to upgrade your electrical equipment, your electric service, or the local grid, will be your responsibility. There may be fees associated with interconnection.

Operations and Maintenance Costs. There may be additional costs of owning and maintaining your solar investment that you will need to consider. For a solar panel to operate efficiently in the winter months, snow removal may be required. Periodic maintenance of the structures may also be needed, particularly if the panel is equipped to track the sun. In addition, you may wish to insure your investment against potential damage. These costs will likely escalate over the life of your investment and should be factored into your financial analysis.

Property Taxes and Insurance. The property taxes and insurance on your home may also change as a result of a solar investment. These costs will need to be included in your financial analysis.



Incentives

There are currently many federal and state financial incentives for the construction of solar energy systems that can offset a portion of the initial investment and improve the project's simple payback or return on investment. The incentives may be tax credits, grants, utility rebates or low-interest loans. While you may be eligible for one or more of the incentives it is important to recognize that the incentives may interact with one another, so you cannot simply sum the incentives to calculate their total value. For example, a grant will either reduce the tax basis on which a tax credit might be applied or alternatively may be considered taxable income from which your Adjusted Gross Income will be increased. Further, a state tax credit will generally increase the federal tax liability thus lessening the sum of the two individually. It is advisable that you visit with a qualified tax advisor to determine the true value of the incentives rather than relying solely on the contractor's estimate of what the incentive value will be. A comprehensive listing with detailed descriptions can be found at the Database of State Incentives for Renewables and Efficiency (DSIRE) website at dsireusa.org.

Constructing the Solar PV Array



After receiving written proposals – preferably from several companies – and comparing the detailed specifications, costs, estimated annual energy generation (and how it was derived), and their references, you are ready to select a contractor for your project.

A signed written contract for the installation of the solar array is the binding document that specifies what equipment will be purchased, where it will be located, when it will be constructed, who is responsible for the different tasks, and how much it will cost.

The contract will often be offered as a “turnkey” contract in which all of the design services, permitting, materials, and labor are included as a single price. In addition to listing the components and costs, the contract should clearly outline:

- Payment schedule and terms
- Timeline for completion
- Statement of workmanship
- Code compliance
- Warranties and guarantees
- Responsibilities for replacement of any components under warranty
- Lien waiver to protect you in the event suppliers have claims against the contractor

Under no situation should you be rushed by the contractor to sign the contract. Be careful to ask questions of areas that you don't understand and consult with your attorney before signing the contract and other legal documents.

Interconnection. Every utility in Iowa has interconnection policies and procedures that you will need to follow, including the completion of an application for an interconnection agreement. Generally, the complexity of this process will depend on the size of the solar energy system that is being installed. The larger the installation, the more reviews, studies, and documentation will be required.

There may be limitations on the amount of generation that can be interconnected on a given circuit, feeder, substation, or overall system. If certain limits are reached, you may be required to pay for upgrades to the distribution system so that the system can accommodate the generation. This is a key reason why it's critical you meet with your utility at the outset of your research process.



DID YOU KNOW ?

Iowa Administrative Code Chapter 45 contains detailed rules that rate-regulated utilities must follow for interconnecting solar and other distributed generation facilities. These rules contain standard interconnection application forms and interconnection agreements. You can find a copy of chapter 45 rules at: www.legis.iowa.gov/docs/iac/chapter/03-02-2016.199.45.pdf. To obtain forms and agreements applicable for your interconnection contact your electric utility.

Each utility's interconnection policies, which are available upon request, must be in compliance with applicable federal and state requirements. The standards for interconnection, safety, and operating reliability applicable to all electric utilities in Iowa can be found in Iowa Administrative Code 199.15.10. You can find a copy of 199.15.10 at legis.iowa.gov/docs/iac/rule/199.15.10.pdf.

You may also wish to consult with a trusted advisor/attorney on these matters, which can be complex. Or if you have a question about interconnection requirements on electric utilities in Iowa, you can contact the Iowa Utilities Board at 515-725-7321 or send an e-mail to customer@iub.iowa.gov.

Inspection. All systems are subject to inspection by a local inspection authority or the state of Iowa, depending on who has jurisdiction. You will need to check with the local municipal or county authorities for more information about electrical permits and inspections. Your utility also may be able to inform you about the need for permits and inspections. Regardless of whether the installation will require an electric permit or inspection, it is always a good idea to consider having the work inspected. Your insurance provider may require an inspection and it also is a good idea for safety reasons.

Your utility also may perform an inspection of the interconnection and test the operation of the generation equipment to ensure the safety of their personnel. The utility may refuse to interconnect if they find that it is constructed or performs in an unsafe manner.



Notifications, Monitoring and Follow-Up



Notifications

As of July 1, 2015, Iowa law requires these notifications or devices be used related to distributed generation systems, which includes solar energy systems.

- **Disconnect device at meter required from July 1 going forward**

For distributed generation systems interconnected on or after July 1, 2015, a disconnect switch or other device capable of disconnecting and de-energizing a distributed generation system must be visible and adjacent to an interconnection consumer's electric meter.

- **Permanent placard required for interconnections prior to July 1**

For installations placed in service prior to July 1, 2015, consumers with an interconnected system must provide and attach a permanent placard at the electric meter that clearly identifies the presence and location of a disconnect device for distributed generation facilities on the property.

- **Notification of local fire department**

Consumers who have a system interconnected must notify local paid or volunteer fire departments of the location of distributed generation facilities and associated disconnection devices upon completion of the installation.

Notifications, Monitoring and Follow-Up of Your Solar Energy System

Monitoring

On a monthly basis, review the production of your solar energy system. Compare this production to the expected production that was provided by the solar installer. If the production is not closely resembling the expected production, contact your installer to review the system to determine why the generation is not as expected and identify any possible fixes.

Maintenance

Make sure to follow any manufacturer recommended maintenance to ensure continued proper performance.

A program of inspection to determine the necessity for any replacement or repair is required to be developed by the generator owner/operator. Representatives of your electric utility must have access to the solar generator and related equipment at all reasonable times for their own inspection and testing.

Additions or Modifications

Contact your electric utility to discuss any additions or modifications to your solar energy system, including energy storage. Changes to your system may necessitate additional applications and upgrades to electric utility facilities. The electric utility can evaluate the proposed changes to determine what upgrades would be needed and estimate the costs of the upgrade. If modifications are made to the solar system without contacting the electric utility, you could create a safety hazard and cause damage to the distribution system. You could be liable for any damages caused and could be subject to disconnection without notice.



Glossary

Application Fee

A charge collected by the electric utility to process the interconnection application. This fee is intended to recover the utility's cost of processing the application for interconnection but not any applicable interconnection costs to connect your solar to the grid.

Avoided Cost

The incremental cost for a utility to produce one more unit of power. For example, because a qualifying facility (QF) as defined under the Public Utilities Regulatory Policies Act or an Alternate Energy Production Facility and as defined in Iowa Code §476.42, reduces the utility's need to produce this additional power themselves, the price utilities pay for QF power has been set to the avoided or marginal cost.

Backup Generator

A generator that is used only for test purposes, or in the event of an emergency, such as a shortage of power needed to meet consumer load requirements.

Backup Power

Electric energy supplied by a utility to replace power and energy lost during an unscheduled equipment outage.

Commissioning Test

A highly specialized activity where a power installation is tested to ensure it meets exacting standards through the integrated application of a set of engineering techniques and procedures to check, inspect and test every operational component of the project, from individual functions, such as instruments and equipment, up to complex amalgamations such as modules, subsystems, and systems.

Consumption (also Energy Consumption)

The use of energy as a source of heat or power or as a raw material input to a manufacturing process.

Dead Load

Dead loads are those that are constant in magnitude and fixed in location throughout the lifetime of the structure. Usually the major part of the dead load is the self-weight of the structure. The dead load can be calculated accurately from the design configuration, dimension of the structure and density of the material. The loads of the beams, columns, foundations, slabs, etc. are the dead loads of a structure.

Electricity Generation

The process of producing electric energy or the amount of electric energy produced by transforming other forms of energy, commonly expressed in kilowatt-hours (kWh) or megawatt-hours (MWh).

Electric Power Grid

A system of synchronized power providers and consumers connected by transmission and distribution lines and operated by one or more control centers. In the continental U.S., the electric power grid consists of three systems: the Eastern Interconnect, the Western Interconnect, and the Texas Interconnect. In Alaska and Hawaii, several systems encompass areas smaller than the State (e.g., the interconnect serving Anchorage, Fairbanks, and the Kenai Peninsula; individual islands).

Energy

The capacity for doing work as measured by the capability of doing work (potential energy) or the conversion of this capability to motion (kinetic energy). Energy has several forms, some of which are easily convertible and can be changed to another form useful for work. Most of the world's convertible energy comes from fossil fuels that are burned to produce heat that is then used as a transfer medium to mechanical or other means in order to accomplish tasks. Electrical energy is usually measured in kilowatt hours while heat energy is usually measured in British thermal units (Btu).

Energy Demand

The requirement for energy as an input to provide products and services.

Energy Efficiency

A ratio of service provided to energy input (e.g., lumens to watts in the case of light bulbs). Services provided can include buildings-sector end uses such as lighting, refrigeration, and heating; industrial processes; or vehicle transportation. Unlike conservation, which involves some reduction of service, energy efficiency provides energy reductions without sacrifice of service. May also refer to the use of technology to reduce the energy needed for a given purpose or service.

Grid

The layout of an electrical distribution system.

Grid-Tie Inverter

A power inverter that converts direct current (DC) electricity into alternating current (AC) with an ability to synchronize to interface with a utility line. Its applications are converting DC sources such as solar panels or small wind turbines into AC for tying with the grid.

IEEE

Institute of Electrical and Electronics Engineers

Interconnection

Two or more electric systems having a common transmission line that permits a flow of energy between them. The physical connection of the electric power transmission facilities allows for the sale or exchange of energy.

Interconnection Agreement

A legal contract for the connection of the solar energy facility to the utility's electric distribution lines, specifying the location, size, cost, manner of payment, terms of operation, and respective responsibilities of the utility and the solar energy consumer.

Interconnection Costs

The reasonable costs of connection, switching, metering, transmission, distribution, safety provisions, and administrative costs incurred by the utility directly related to the installation and maintenance of a consumer's solar energy facility.

IUB

Iowa Utilities Board

Kilowatt

A unit of power equal to 1,000 watts.

Kilowatt Hour (kWh)

A measure of electricity defined as a unit of work or energy, measured as 1 kilowatt (1,000 watts) of power expended for 1 hour. One kWh is equivalent to 3,412 Btu.

Load

An end-use device or consumer that receives power from the electric system.

Load Profile

A graph of the variation in the electrical load vs. time. A load profile will vary according to consumer type (typical examples include residential, commercial and industrial), temperature and holiday seasons.

Net Metering

A service to an electric consumer under which electric energy generated by that electric consumer from an eligible on-site generating facility and delivered to the local distribution facilities may be used to offset electric energy provided by the electric utility to the electric consumer during the applicable billing period.

Output

The amount of power or energy produced by a generating unit, station, or system.

Photovoltaic (PV)

Energy radiated by the sun as electromagnetic waves (electromagnetic radiation) that is converted into electricity by means of solar (photovoltaic) cells or concentrating (focusing) collectors.

Settlement Date

The date your utility uses to settle or reconcile an account for purchases that have been made from the grid and excess energy a solar panel has delivered to the grid.

Solar Energy

The radiant energy of the sun, which can be converted into other forms of energy, such as heat or electricity.

Storage Capacity

The amount of energy a storage device or system can store.

Usage

The amount of energy or electricity used by a consumer.

For More Information

Alliant Energy

Iowa Corporate Address:
200 1st Street SE
Cedar Rapids, IA 52401

Mailing address:

Alliant Energy Renewable Hotline
GO-16, P.O. Box 351
Cedar Rapids, IA 52406-0351
Phone: 800-972-5325
Email: sellmypower@alliantenergy.com

Iowa Association of Electric Cooperatives

8525 Douglas Ave., Suite 48
Des Moines, IA 50322-2992
Website: www.iowarec.org
For more information on solar, contact your local electric co-op directly.

Iowa Association of Municipal Utilities

735 NE 70th Ave.
Ankeny, IA 50021-9353
Phone: 515-289-1999
Website: www.iamu.org

Iowa Office of Consumer Advocate

1375 E. Court Ave.
Des Moines, IA 50319-0063
Phone: 515-725-7200
Email: iowaoca@mail.oca.state.ia.us

Iowa Utilities Board

1375 E. Court Ave., Room 69
Des Moines, IA 50319-0069
Phone: 515-725-7300
Website: www.state.ia.us/iub

MidAmerican Energy

666 Grand Ave.
P.O. Box 657
Des Moines, IA 50303-0657
Phone: 888-427-5632
Website: www.midamericanenergy.com



Iowa Energy Center

2521 University Boulevard, Suite 124, Ames, IA 50010-8629
Phone: 515-294-8819 | Fax: 515-294-9912
E-mail: iec@iastate.edu
Website: www.iowaenergycenter.org

This is an Iowa Energy Center publication.

The Iowa Energy Center supports economic development, environmental sustainability, and social well-being in Iowa through energy innovation, education, and entrepreneurship. We provide Iowans with reliable, objective information on energy and efficiency options.